

Rez-de-chaussée

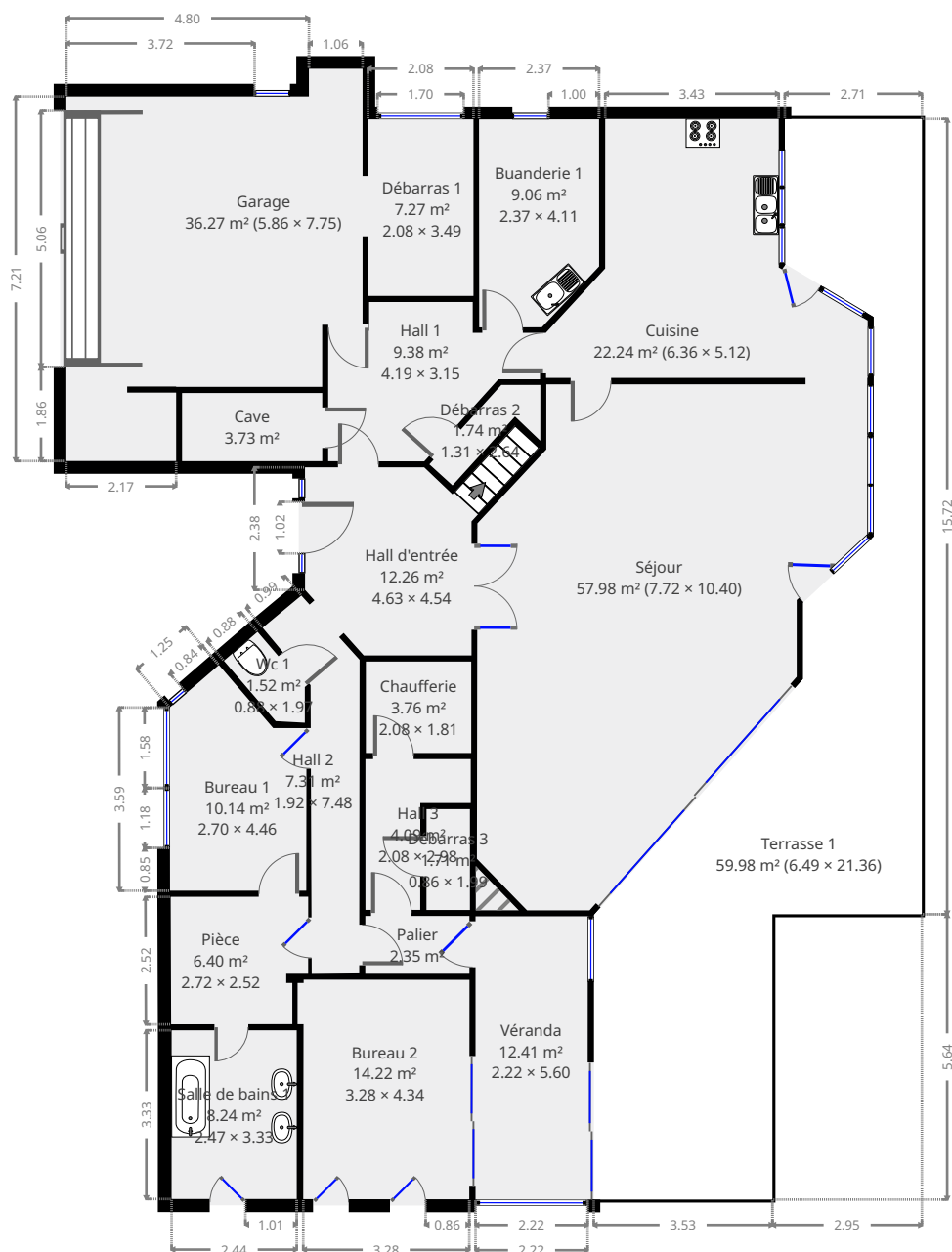

CE PLAN EST FOURNI EN L'ETAT SANS GARANTIE D'AUCUNE SORTIE. SENSOPIA N'ACCORDE AUCUNE GARANTIE, Y COMPRIS, SANS S'Y LIMITER, DES GARANTIES QUANT À LA QUALITÉ ET À LA PRÉCISION DES DIMENSIONS.



# Rêvimmo - 3828910

## Hall 2

Largeur	1.92 m
Longeur:	7.48 m
Superficie	7.31 m <sup>2</sup>
Périmètre:	17.03 m

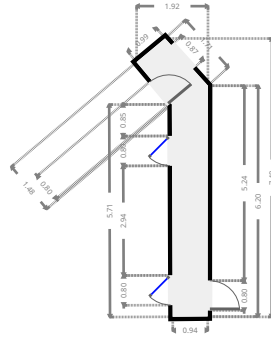

## Terrasse 1

Largeur	6.49 m
Longeur:	21.36 m
Superficie	59.98 m <sup>2</sup>
Périmètre:	55.08 m

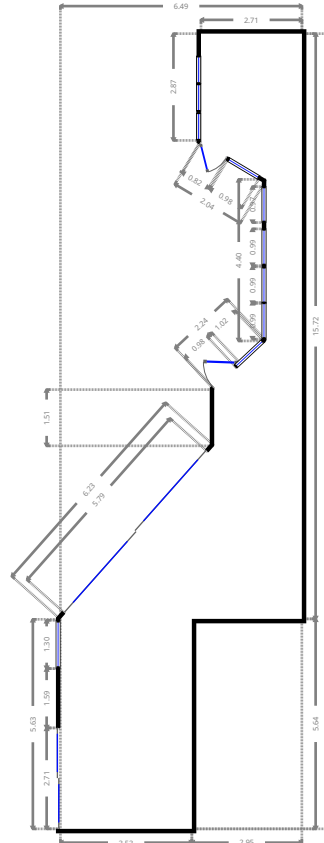
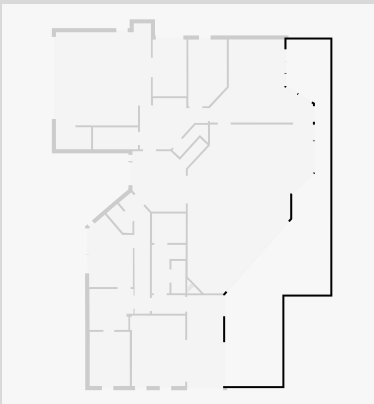

CE PLAN EST FOURNI EN L'ETAT SANS GARANTIE D'AUCUNE SORT. SENSOPIA N'ACCORDE AUCUNE GARANTIE, Y COMPRIS, SANS S'Y LIMITER, DES GARANTIES QUANT À LA QUALITE ET À LA PRÉCISION DES DIMENSIONS.

# Rêvimmo - 3828910

## Véranda

Largeur 2.22 m  
Longeur: 5.60 m  
Superficie 12.41 m<sup>2</sup>  
Périmètre: 15.63 m

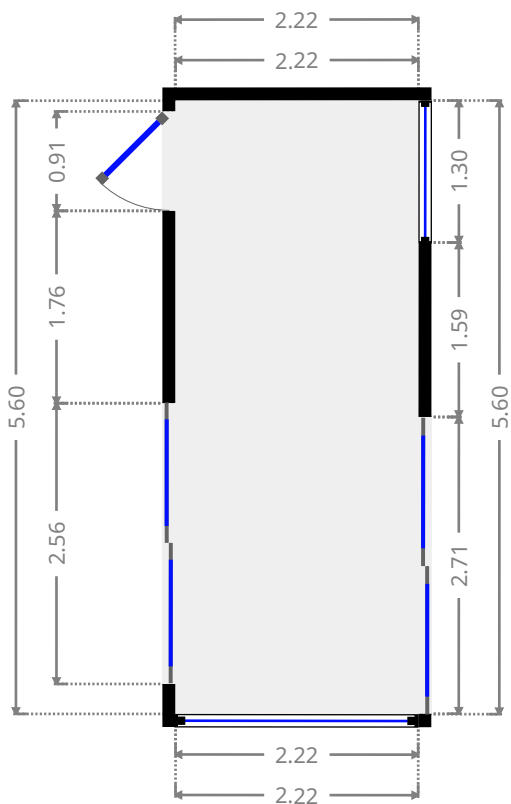

## Bureau 2

Largeur 3.28 m  
Longeur: 4.34 m  
Superficie 14.22 m<sup>2</sup>  
Périmètre: 15.23 m

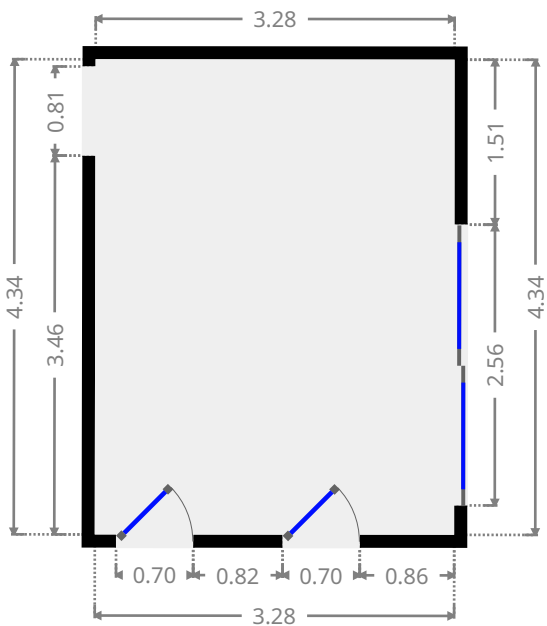

# Rêvimmo - 3828910

## Salle de bains 1

Largeur 2.47 m  
Longeur: 3.33 m  
Superficie 8.24 m<sup>2</sup>  
Périmètre: 11.61 m

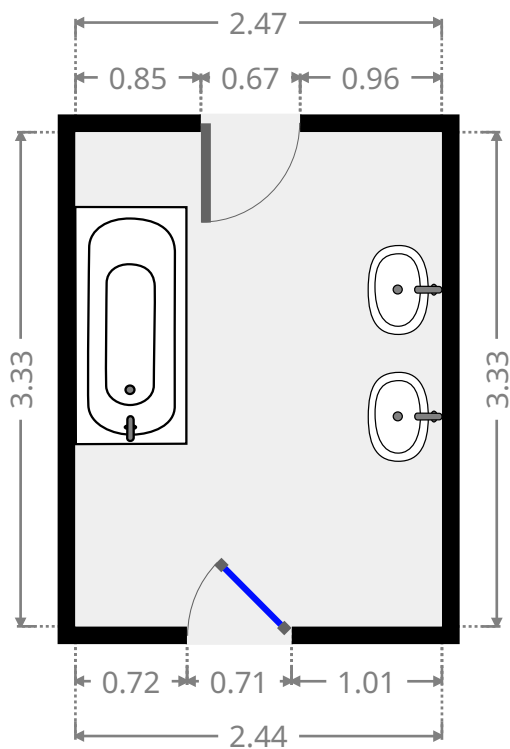

## Pièce

Largeur 2.52 m  
Longeur: 2.72 m  
Superficie 6.40 m<sup>2</sup>  
Périmètre: 10.46 m

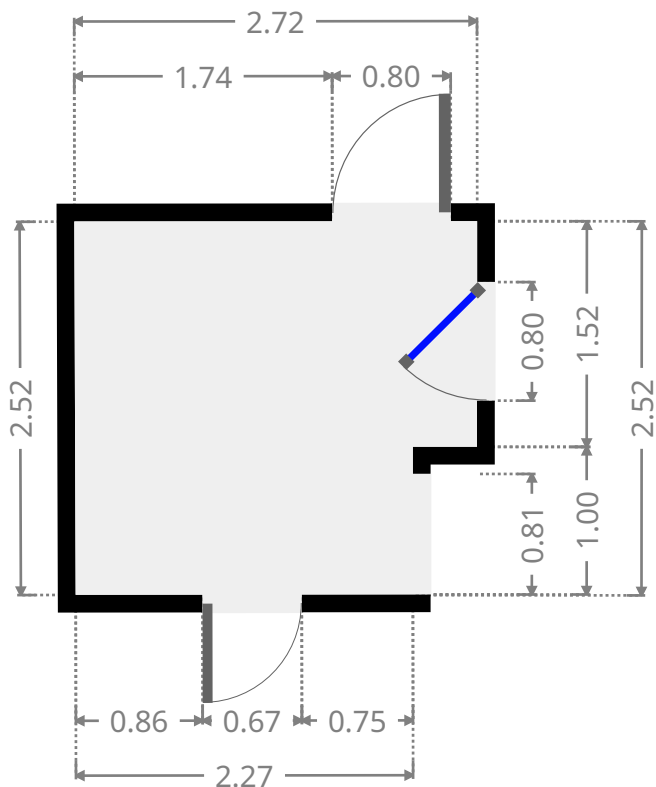
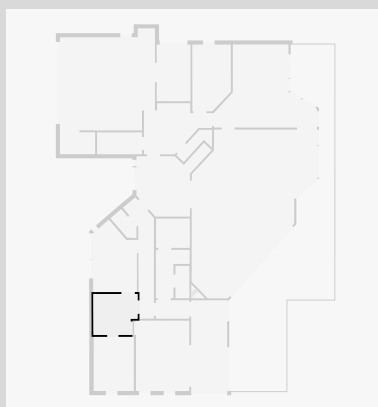

# Rêvimmo - 3828910

## Hall 3

Largeur 2.08 m  
Longeur: 2.98 m  
Superficie 4.09 m<sup>2</sup>  
Périmètre: 10.12 m

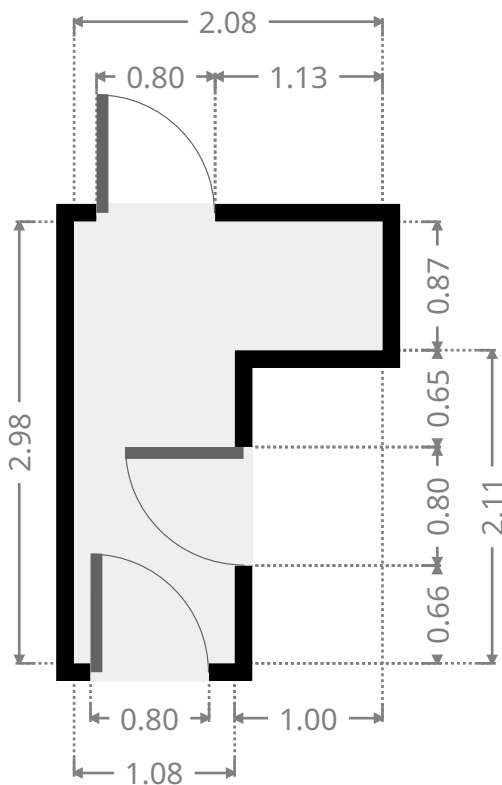

## Palier

Largeur 1.14 m  
Longeur: 2.06 m  
Superficie 2.35 m<sup>2</sup>  
Périmètre: 6.40 m

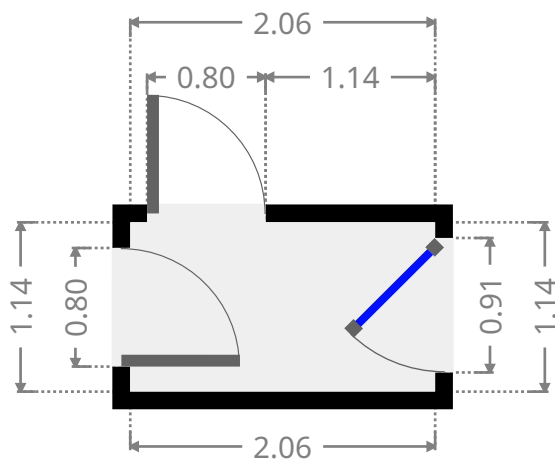

## Rêvimmo - 3828910

### Débarras 3

Largeur 0.86 m  
Longeur: 1.99 m  
Superficie 1.71 m<sup>2</sup>  
Périmètre: 5.70 m

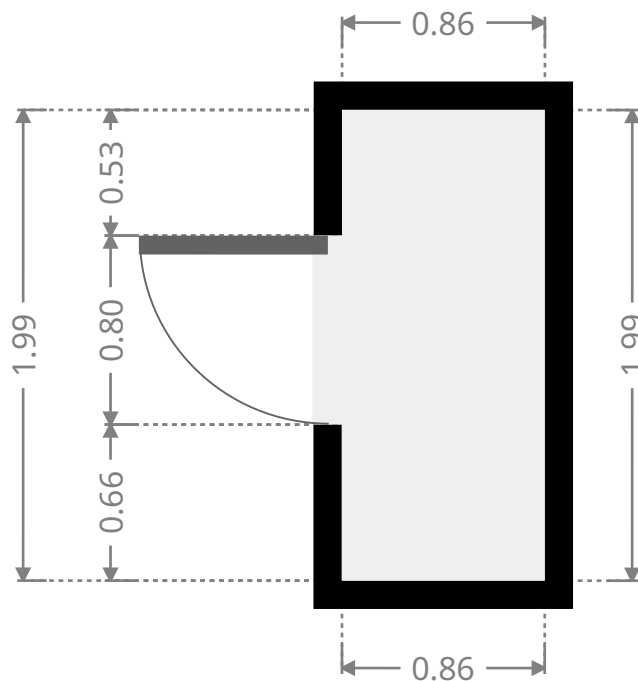

### Chaufferie

Largeur 1.81 m  
Longeur: 2.08 m  
Superficie 3.76 m<sup>2</sup>  
Périmètre: 7.78 m

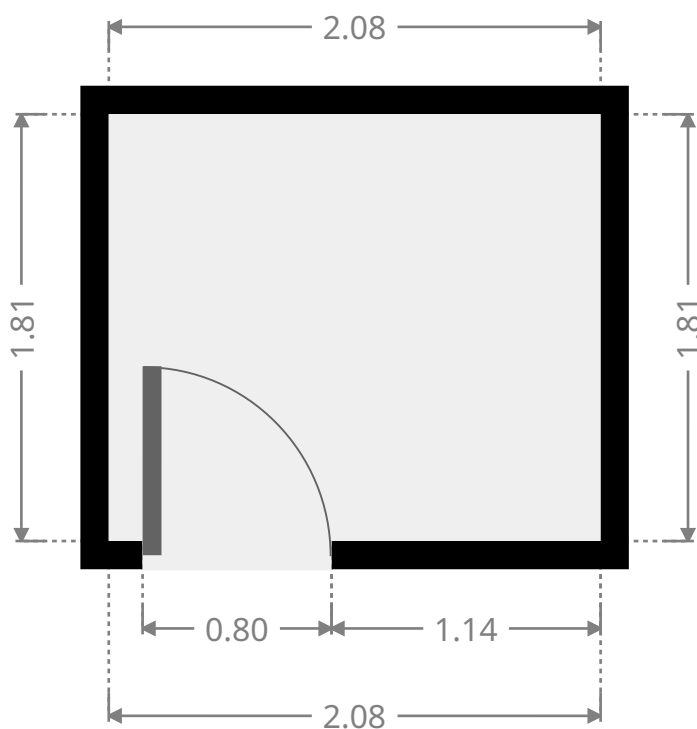
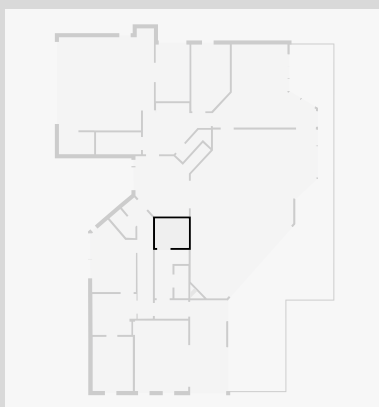

# Rêvimmo - 3828910

## Bureau 1

Largeur 2.70 m  
Longeur: 4.46 m  
Superficie 10.14 m<sup>2</sup>  
Périmètre: 13.11 m

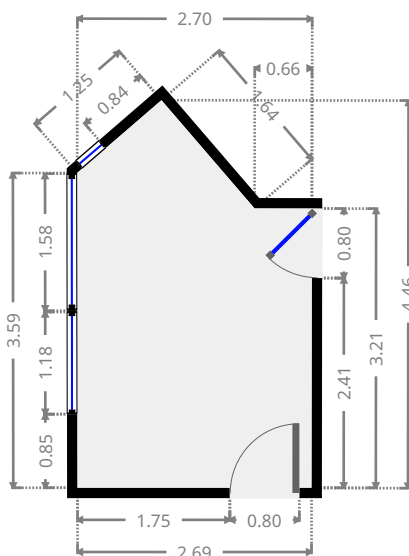

## Garage

Largeur 5.86 m  
Longeur: 7.75 m  
Superficie 36.27 m<sup>2</sup>  
Périmètre: 29.16 m

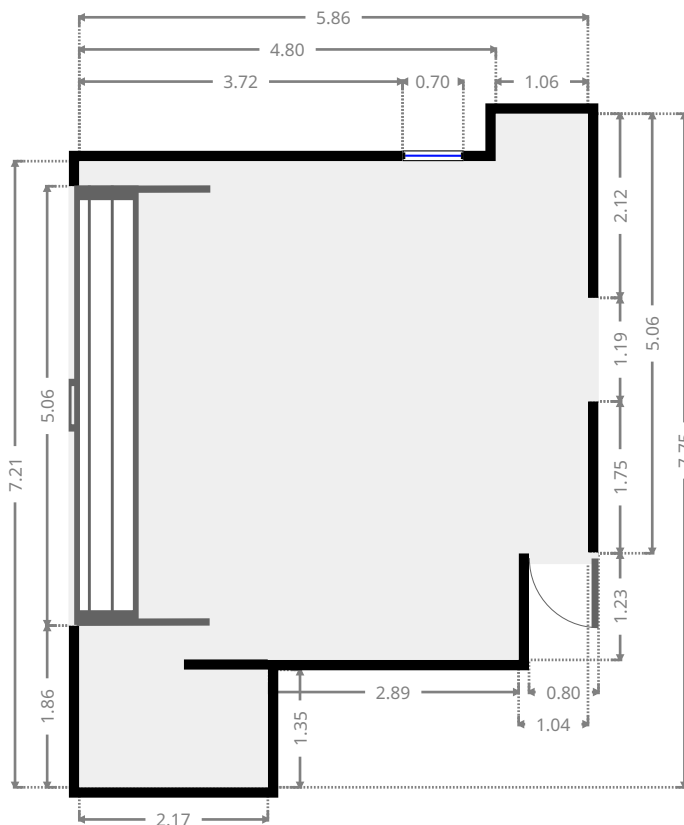
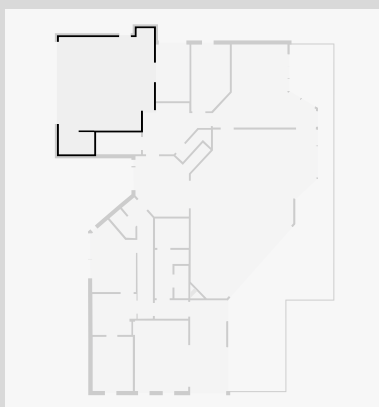

CE PLAN EST FOURNI EN L'ETAT SANS GARANTIE D'AUCUNE SORTE. SENSOPIA N'ACCORDE AUCUNE GARANTIE, Y COMPRIS, SANS S'Y LIMITER, DES GARANTIES QUANT À LA QUALITE ET À LA PRÉCISION DES DIMENSIONS.

# Rêvimmo - 3828910

## Wc 1

Largeur 0.88 m  
Longeur: 1.97 m  
Superficie 1.52 m<sup>2</sup>  
Périmètre: 5.17 m

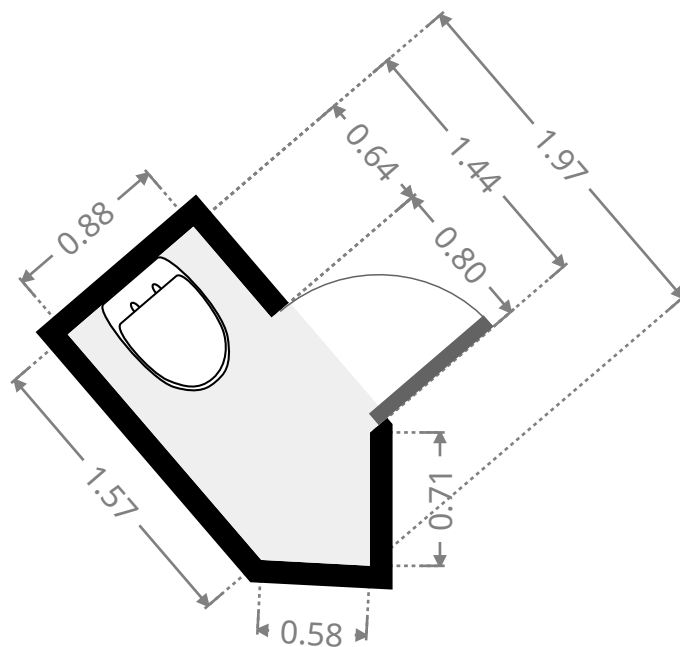

## Débarras 2

Largeur 1.31 m  
Longeur: 2.64 m  
Superficie 1.74 m<sup>2</sup>  
Périmètre: 7.14 m

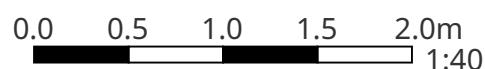
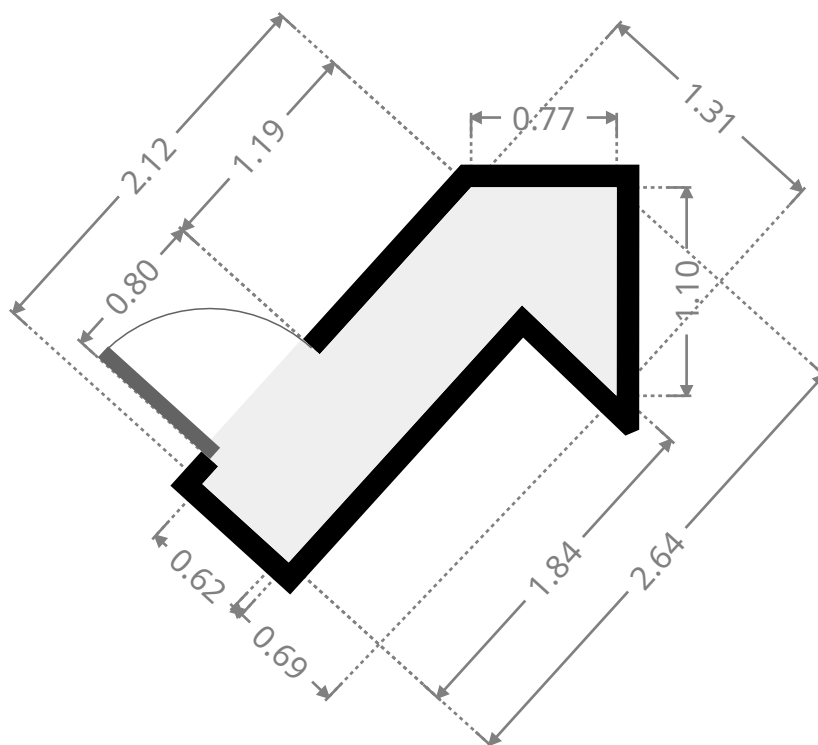



# Rêvimmo - 3828910

## Hall d'entrée

Largeur 4.54 m  
Longeur: 4.63 m  
Superficie 12.26 m<sup>2</sup>  
Périmètre: 16.54 m

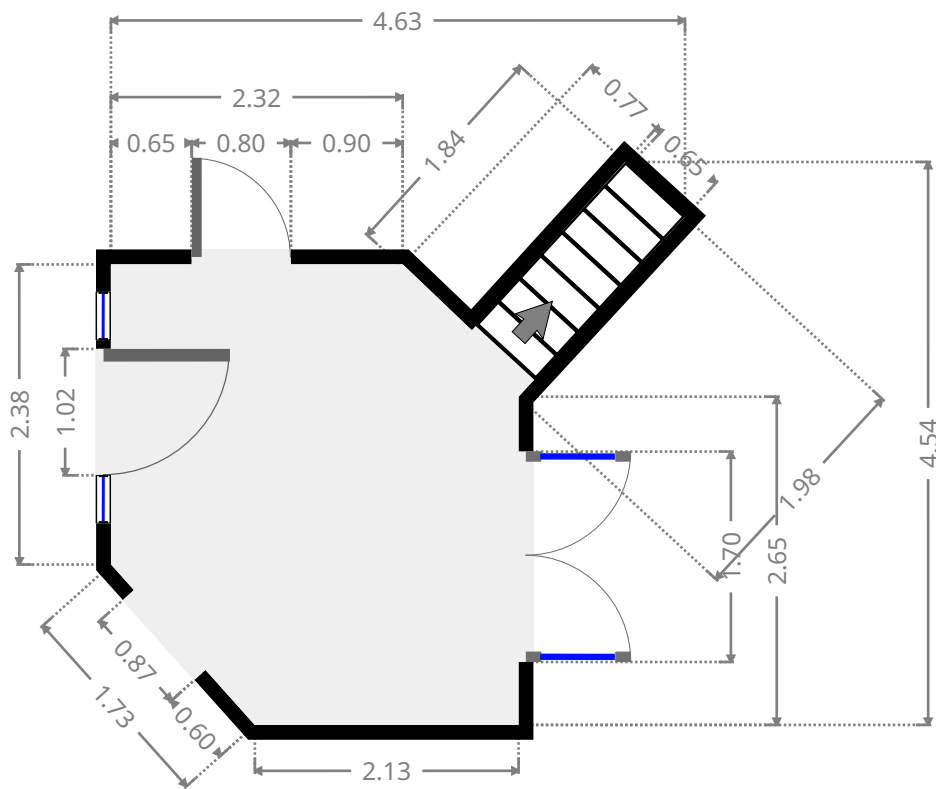

## Cave

Largeur 1.35 m  
Longeur: 2.77 m  
Superficie 3.73 m<sup>2</sup>  
Périmètre: 8.23 m

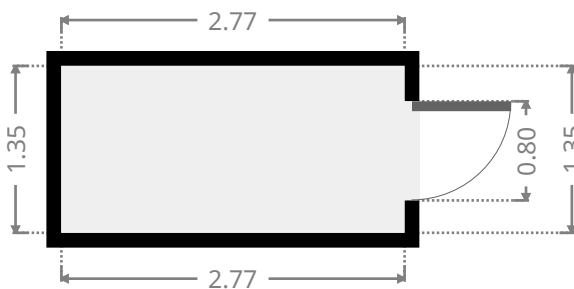

# Rêvimmo - 3828910

## Hall 1

Largeur 3.15 m  
Longeur: 4.19 m  
Superficie 9.38 m<sup>2</sup>  
Périmètre: 13.77 m

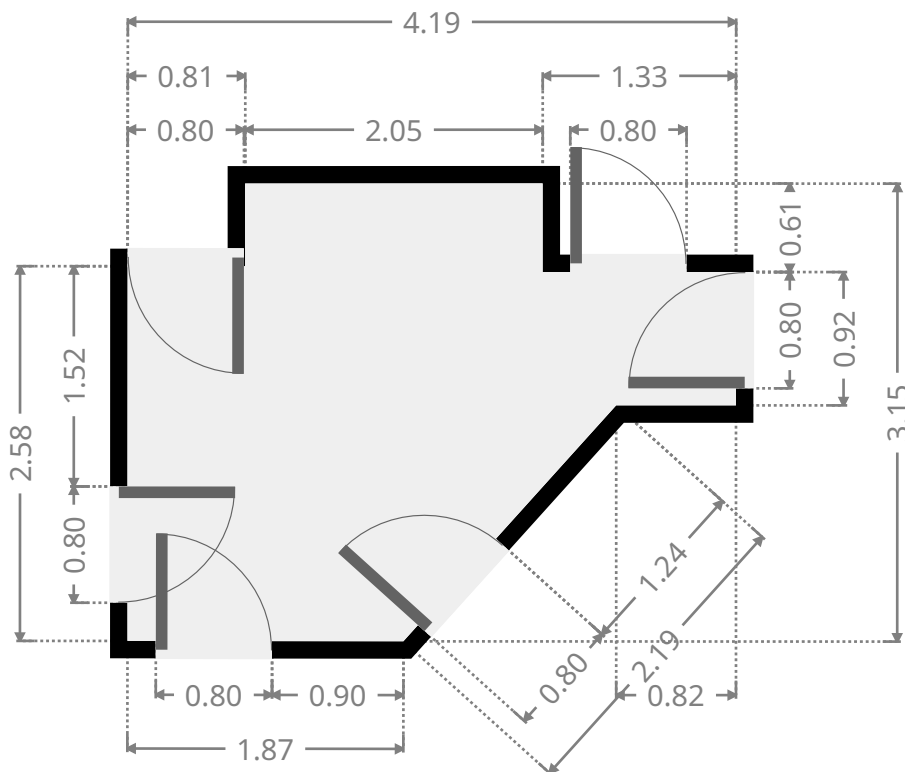

## Débarras 1

Largeur 2.08 m  
Longeur: 3.49 m  
Superficie 7.27 m<sup>2</sup>  
Périmètre: 11.15 m

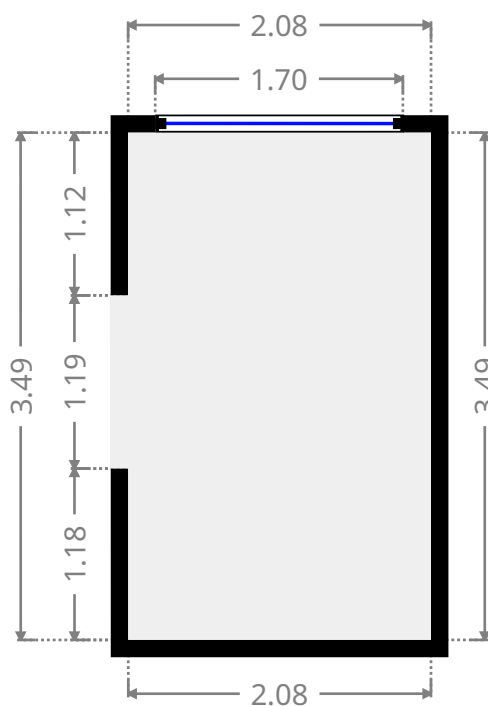

# Révimmo - 3828910

## Séjour

Largeur 7.72 m  
Longeur: 10.40 m  
Superficie 57.98 m<sup>2</sup>  
Périmètre: 31.47 m

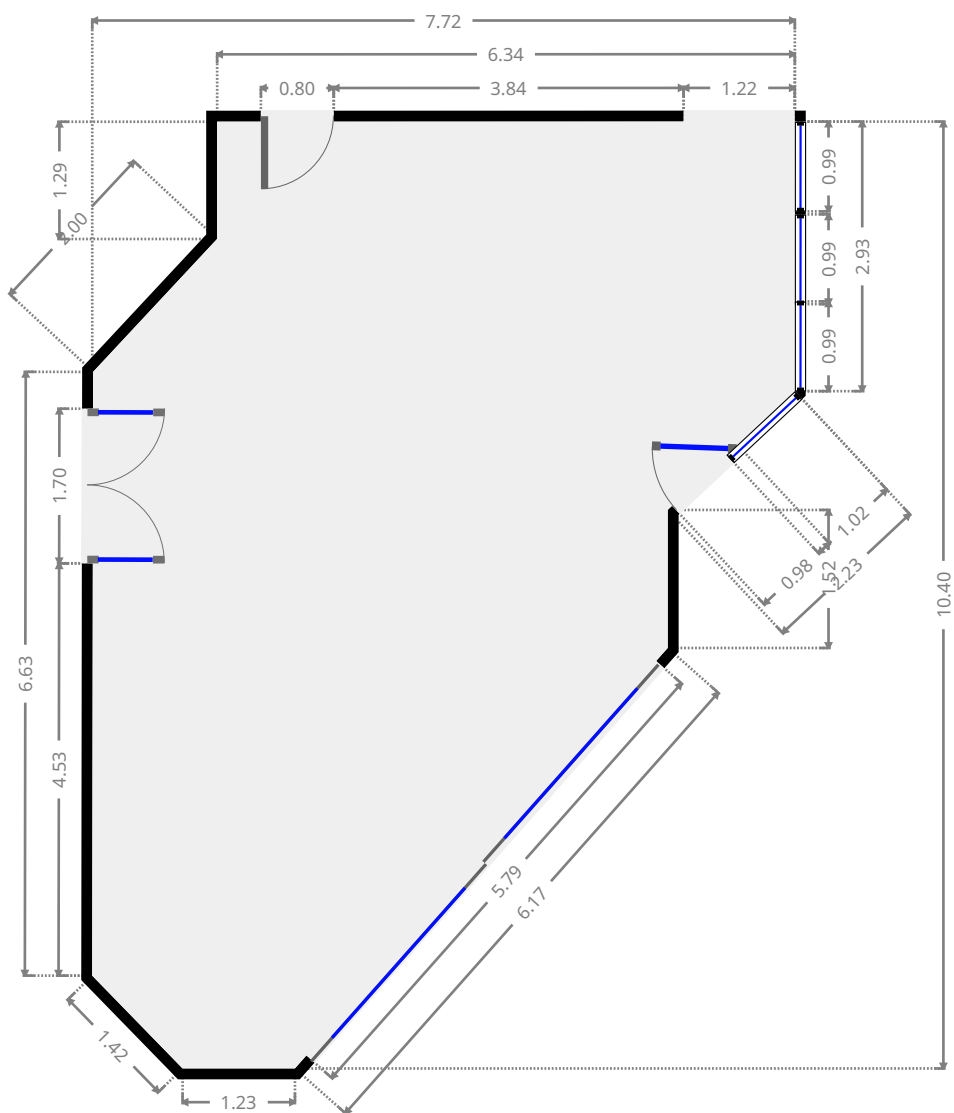

CE PLAN EST FOURNI EN L'ETAT SANS GARANTIE D'AUCUNE SORTE. SENSOPIA N'ACCORDE AUCUNE GARANTIE, Y COMPRIS, SANS S'Y LIMITER, DES GARANTIES QUANT À LA QUALITE ET À LA PRÉCISION DES DIMENSIONS.

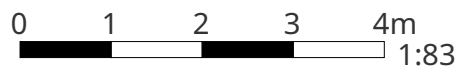

# Rêvimmo - 3828910

## Cuisine

Largeur 5.12 m  
Longeur: 6.36 m  
Superficie 22.24 m<sup>2</sup>  
Périmètre: 21.47 m

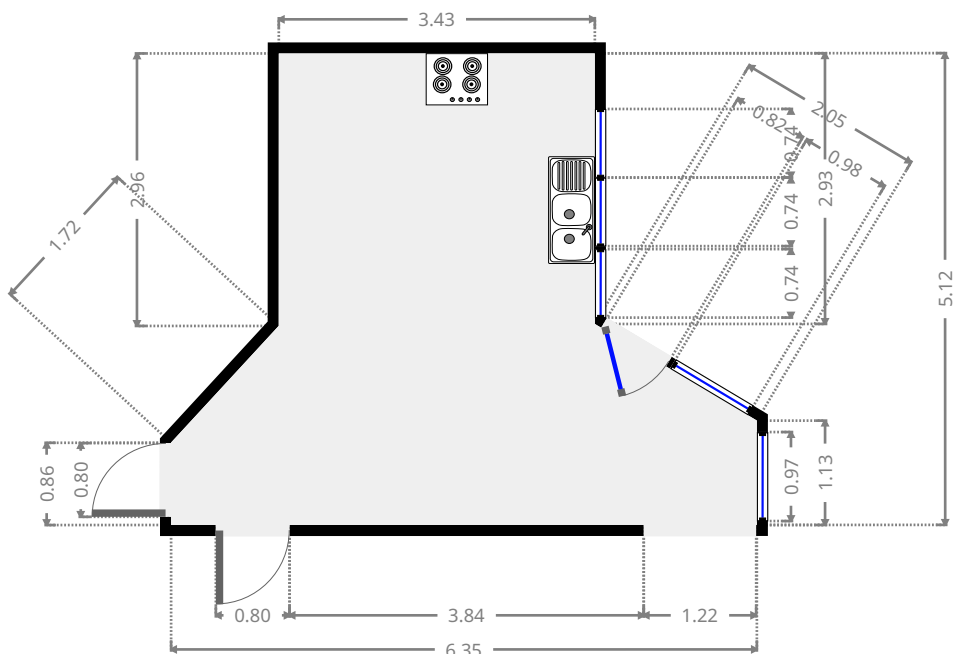

## Buanderie 1

Largeur 2.37 m  
Longeur: 4.11 m  
Superficie 9.06 m<sup>2</sup>  
Périmètre: 12.28 m

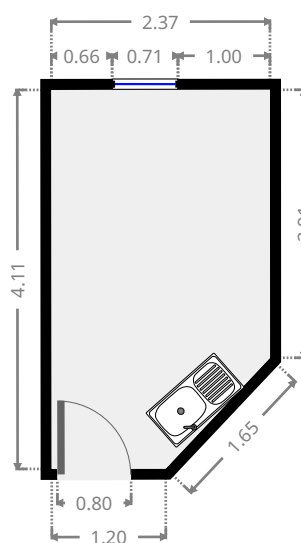

# Rêvimmo - 3828910

## 1er étage

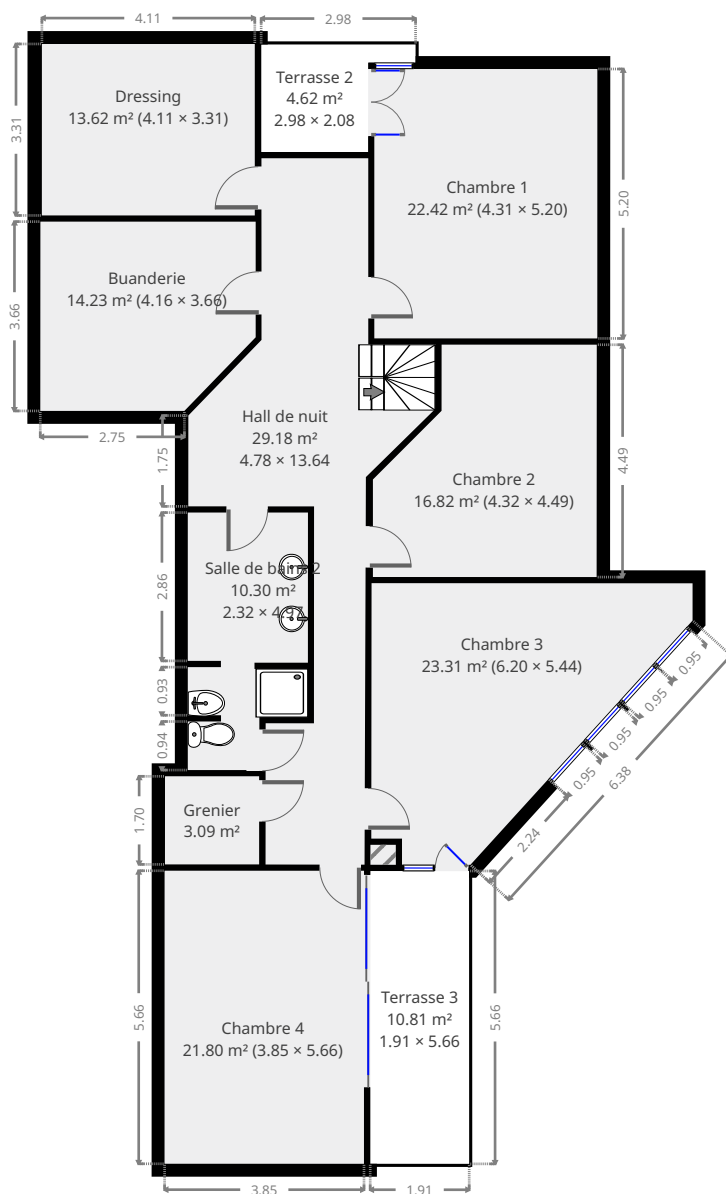

CE PLAN EST FOURNI EN L'ETAT SANS GARANTIE D'AUCUNE SORTE. SENSOPIA N'ACCORDE AUCUNE GARANTIE, Y COMPRIS, SANS S'Y LIMITER, DES GARANTIES QUANT À LA QUALITE ET À LA PRÉCISION DES DIMENSIONS.



# Rêvimmo - 3828910

## Dressing

Largeur 3.31 m  
Longeur: 4.11 m  
Superficie 13.62 m<sup>2</sup>  
Périmètre: 14.85 m

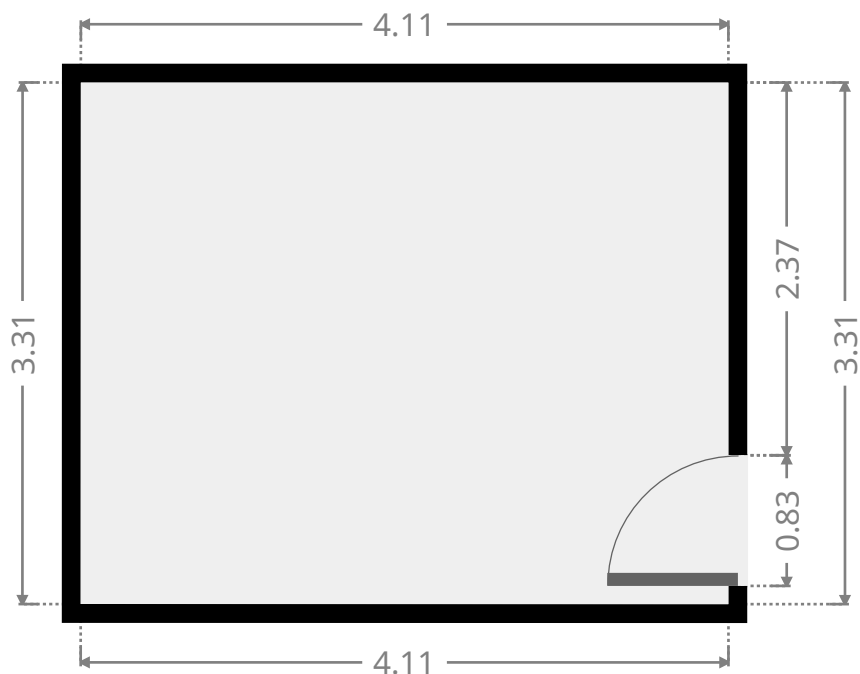
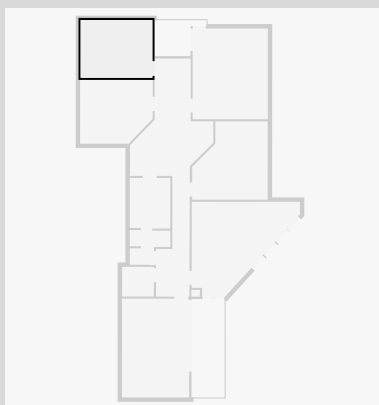

## Buanderie 2

Largeur 3.66 m  
Longeur: 4.16 m  
Superficie 14.23 m<sup>2</sup>  
Périmètre: 14.81 m

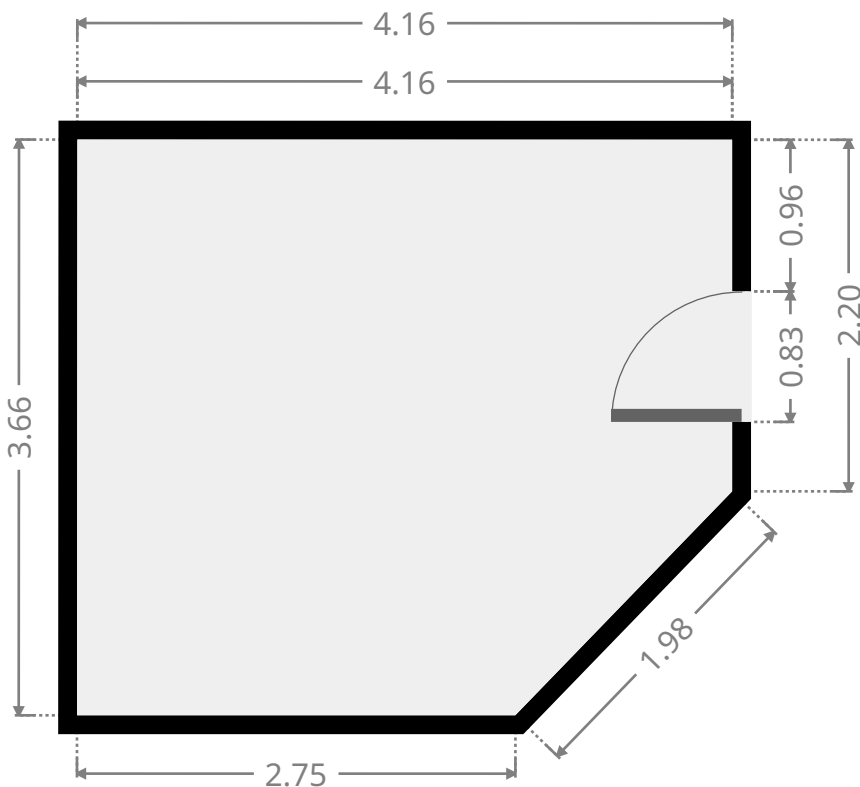
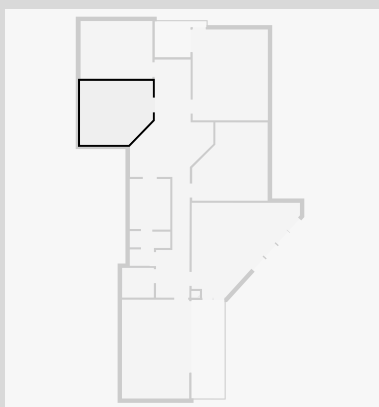

CE PLAN EST FOURNI EN L'ETAT SANS GARANTIE D'AUCUNE SORTE. SENSOPIA N'ACCORDE AUCUNE GARANTIE, Y COMPRIS, SANS S'Y LIMITER, DES GARANTIES QUANT À LA QUALITE ET À LA PRÉCISION DES DIMENSIONS.

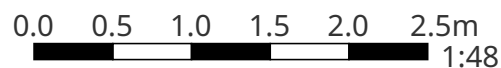

# Rêvimmo - 3828910

## Chambre 1

Largeur 4.31 m  
Longueur: 5.20 m  
Superficie 22.42 m<sup>2</sup>  
Périmètre: 19.02 m

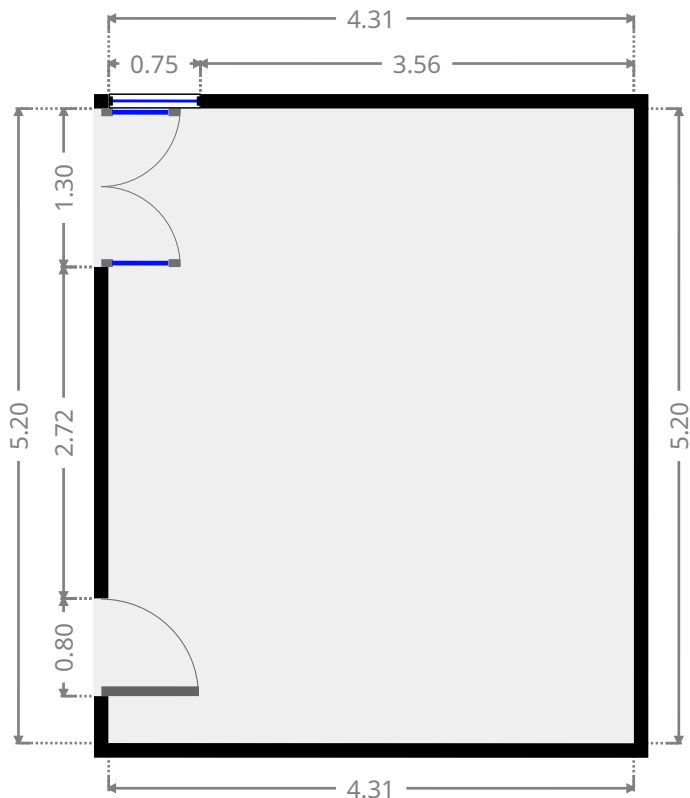
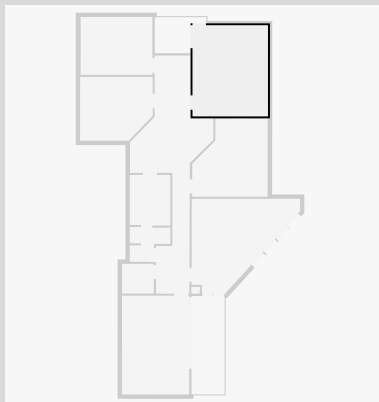

## Chambre 2

Largeur 4.32 m  
Longueur: 4.49 m  
Superficie 16.82 m<sup>2</sup>  
Périmètre: 16.84 m

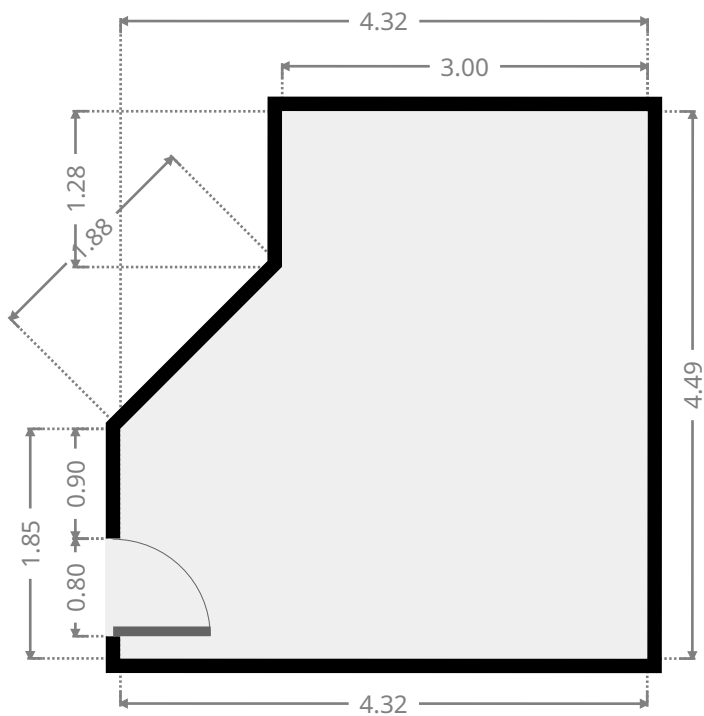
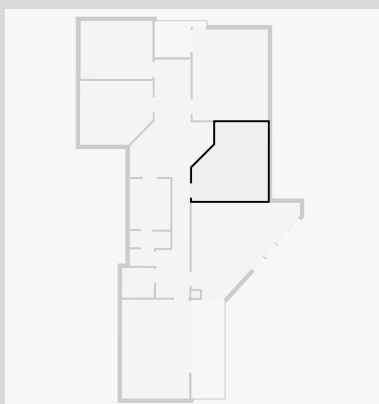

# Rêvimmo - 3828910

## Terrasse 2

Largeur 2.08 m  
Longeur: 2.98 m  
Superficie 4.62 m<sup>2</sup>  
Périmètre: 10.12 m

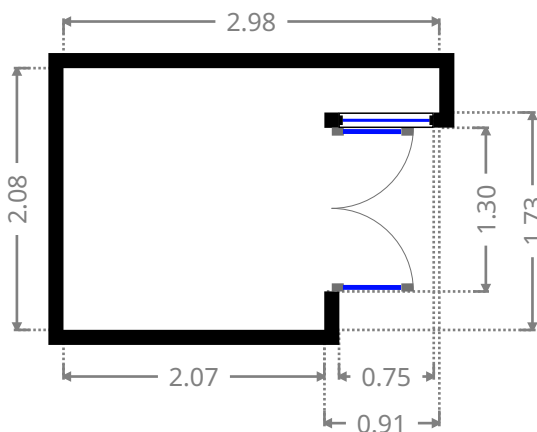
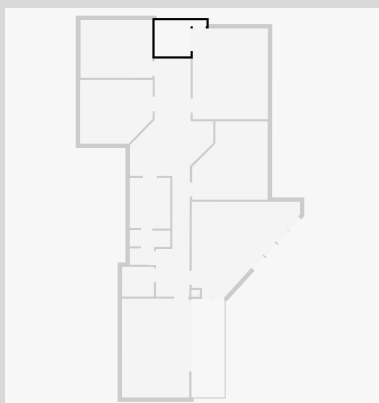

## Salle de bains 2

Largeur 2.32 m  
Longeur: 4.97 m  
Superficie 10.30 m<sup>2</sup>  
Périmètre: 19.22 m

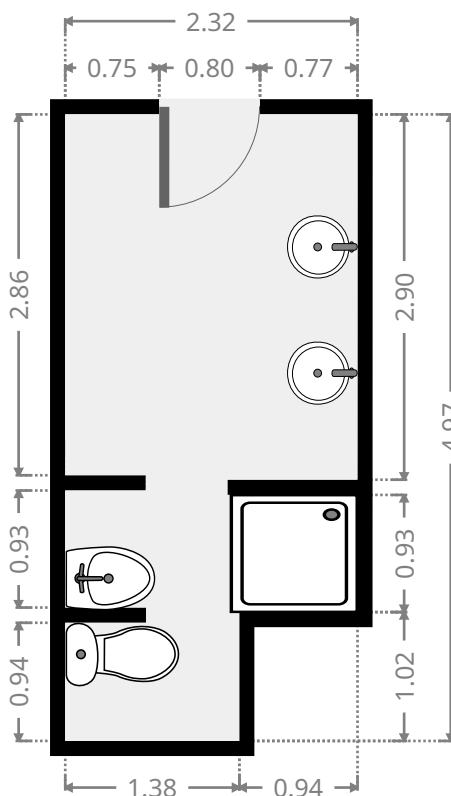
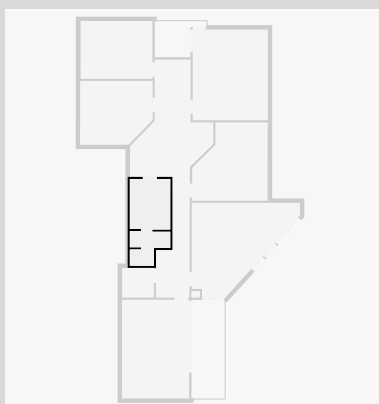

CE PLAN EST FOURNI EN L'ETAT SANS GARANTIE D'AUCUNE SORTE. SENSOPIA N'ACCORDE AUCUNE GARANTIE, Y COMPRIS, SANS S'Y LIMITER, DES GARANTIES QUANT À LA QUALITE ET À LA PRÉCISION DES DIMENSIONS.

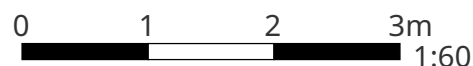



# Rêvimmo - 3828910

## Hall de nuit

Largeur 4.78 m  
Longeur: 13.64 m  
Superficie 29.18 m<sup>2</sup>  
Périmètre: 37.06 m

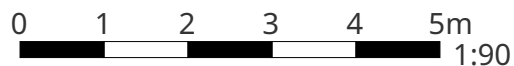
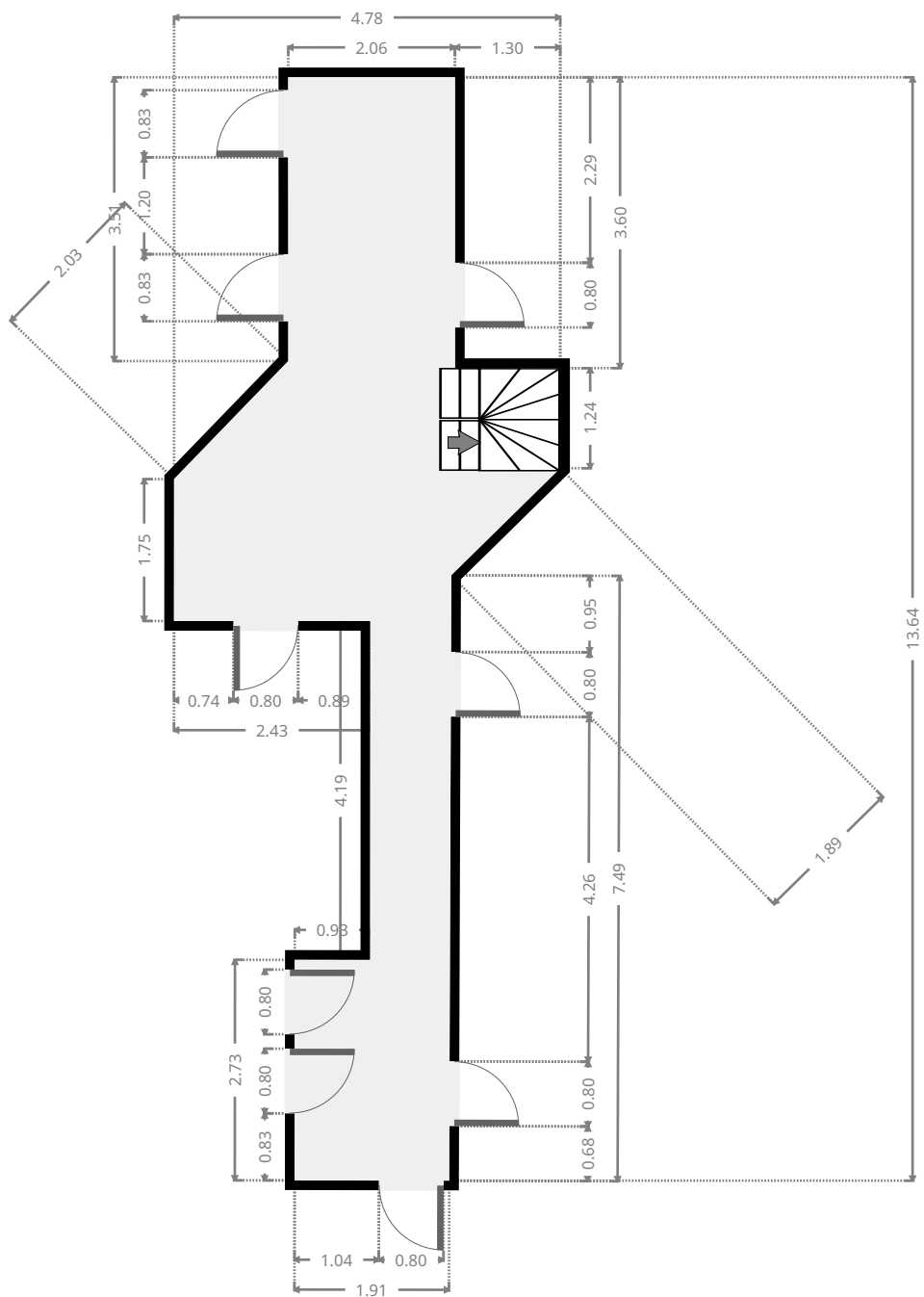
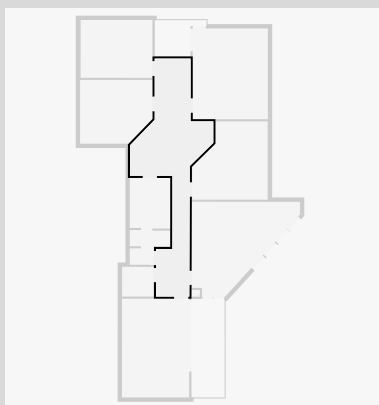

CE PLAN EST FOURNI EN L'ETAT SANS GARANTIE D'AUCUNE SORTE. SENSOPIA N'ACCORDE AUCUNE GARANTIE, Y COMPRIS, SANS S'Y LIMITER, DES GARANTIES QUANT À LA QUALITE ET À LA PRÉCISION DES DIMENSIONS.

# Rêvimmo - 3828910

## Chambre 3

Largeur 5.44 m  
Longeur: 6.20 m  
Superficie 23.31 m<sup>2</sup>  
Périmètre: 20.65 m

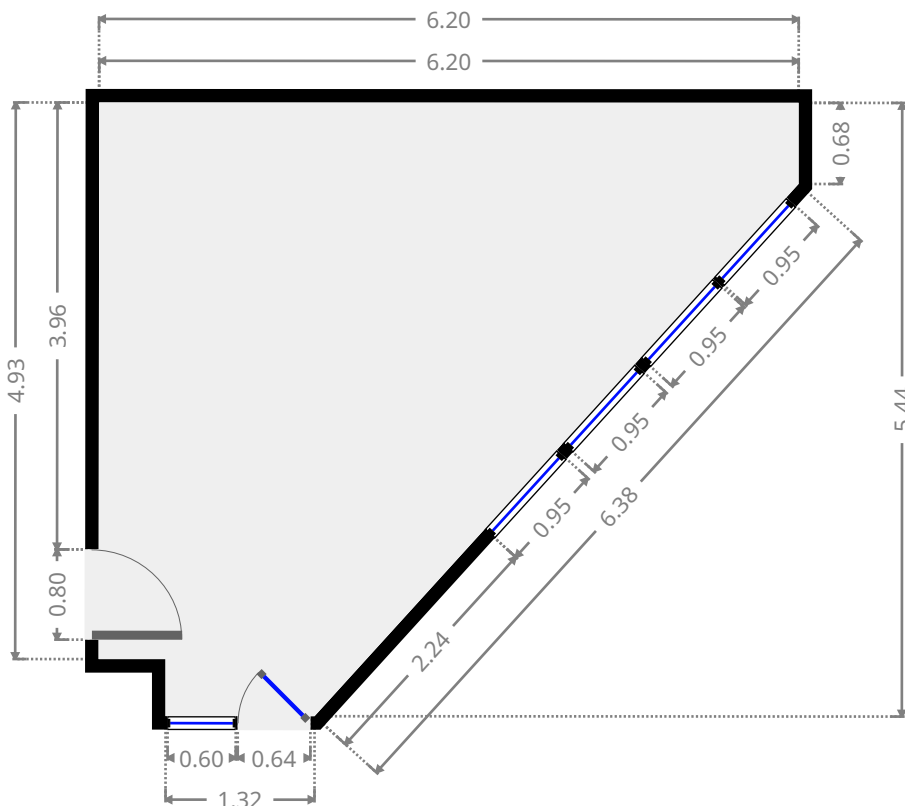
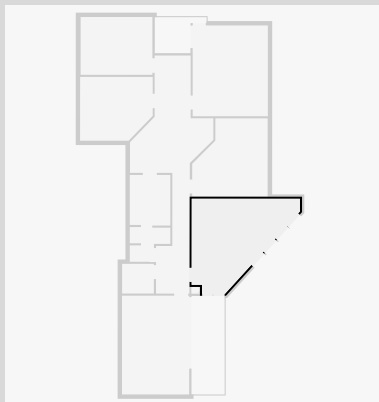

## Grenier

Largeur 1.70 m  
Longeur: 1.82 m  
Superficie 3.09 m<sup>2</sup>  
Périmètre: 7.04 m

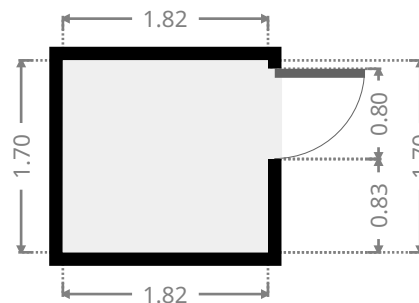
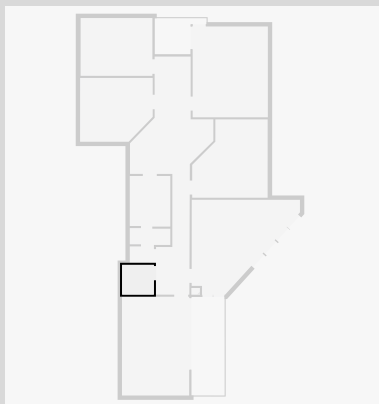

# Rêvimmo - 3828910

## Chambre 4

Largeur 3.85 m  
Longeur: 5.66 m  
Superficie 21.80 m<sup>2</sup>  
Périmètre: 19.02 m

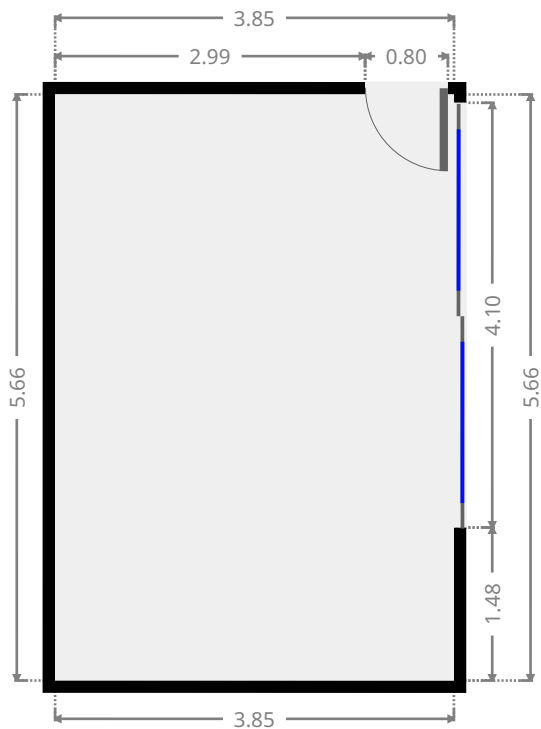
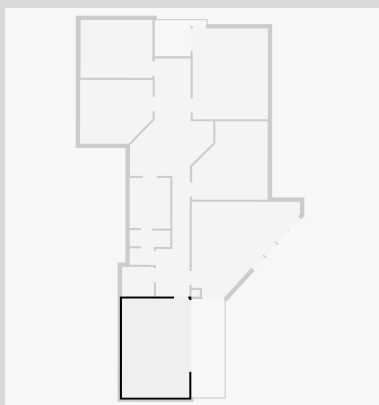

## Terrasse 3

Largeur 1.91 m  
Longeur: 5.66 m  
Superficie 10.81 m<sup>2</sup>  
Périmètre: 15.13 m

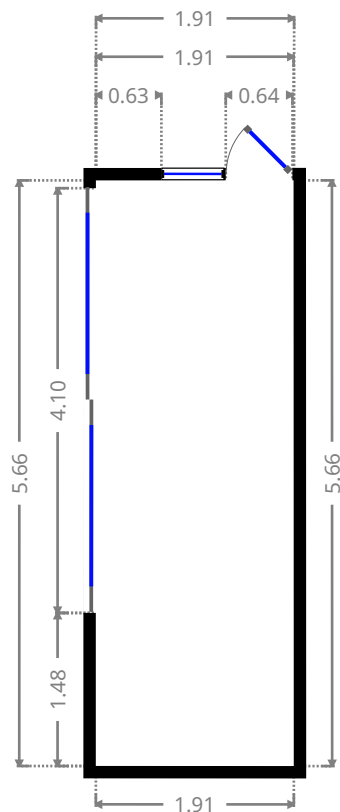
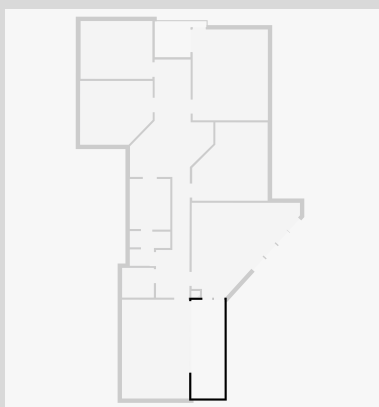

CE PLAN EST FOURNI EN L'ETAT SANS GARANTIE D'AUCUNE SORTE. SENSOPIA N'ACCORDE AUCUNE GARANTIE, Y COMPRIS, SANS S'Y LIMITER, DES GARANTIES QUANT À LA QUALITE ET À LA PRÉCISION DES DIMENSIONS.