

# Révimmo - 3794660

## Rez-de-chaussée

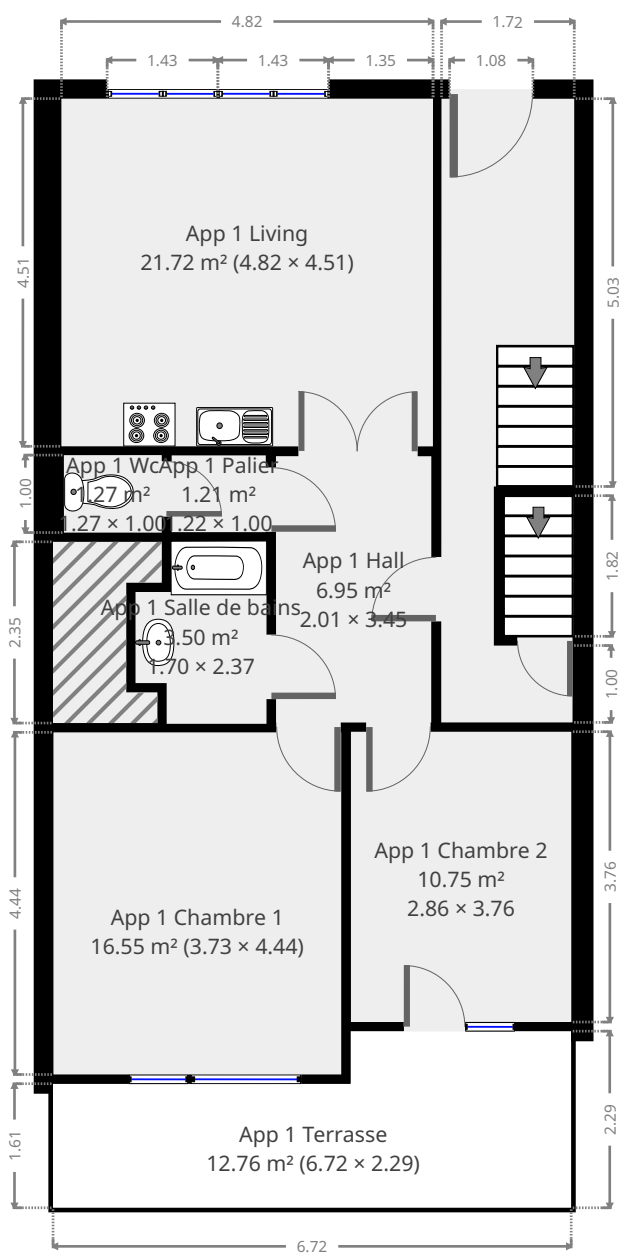

CE PLAN EST FOURNI EN L'ETAT SANS GARANTIE D'AUCUNE SORTE. SENSOPIA N'ACCORDE AUCUNE GARANTIE, Y COMPRIS, SANS S'Y LIMITER, DES GARANTIES QUANT À LA QUALITÉ ET À LA PRÉCISION DES DIMENSIONS.



# Rêvimmo - 3794660

## App 1 Living

Largeur 4.51 m  
Longeur: 4.82 m  
Superficie 21.72 m<sup>2</sup>  
Périmètre: 18.65 m

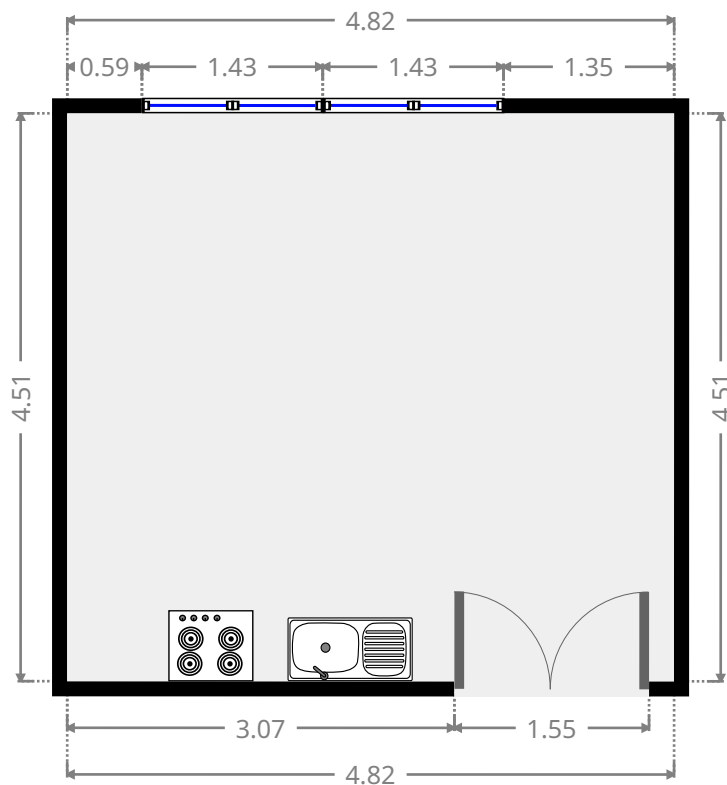
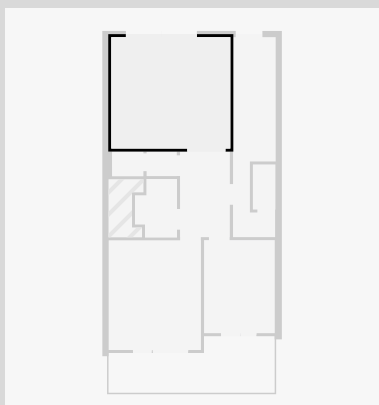

## App 1 Hall

Largeur 2.01 m  
Longeur: 3.45 m  
Superficie 6.95 m<sup>2</sup>  
Périmètre: 10.93 m

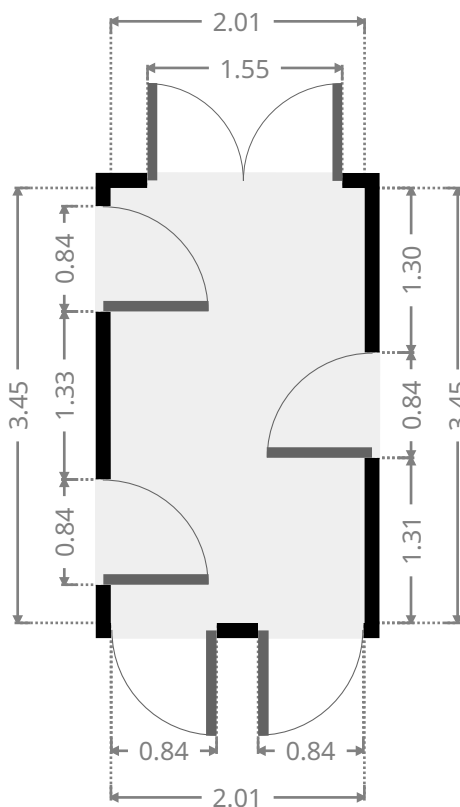
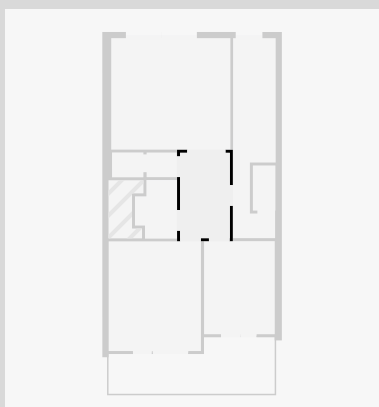

# Rêvimmo - 3794660

## App 1 Palier

Largeur 1.00 m  
Longeur: 1.22 m  
Superficie 1.21 m<sup>2</sup>  
Périmètre: 4.43 m

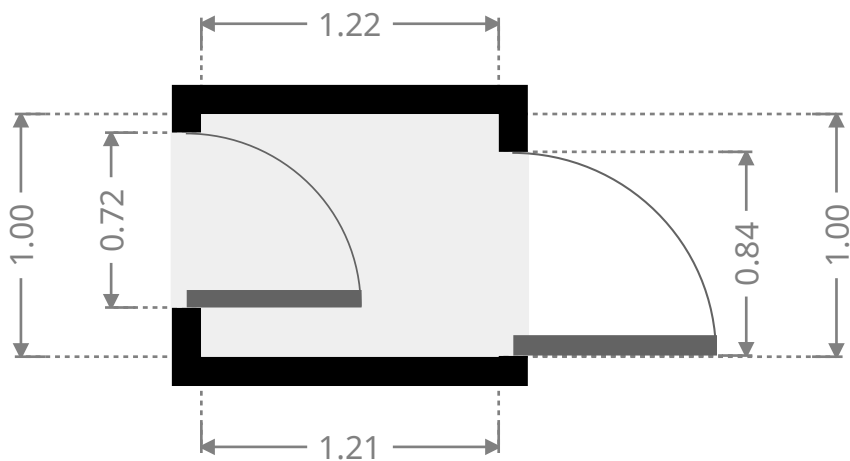
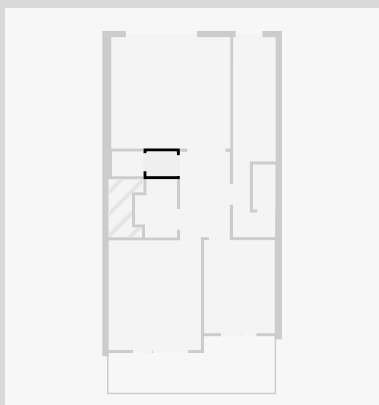

## App 1 Wc

Largeur 1.00 m  
Longeur: 1.27 m  
Superficie 1.27 m<sup>2</sup>  
Périmètre: 4.55 m

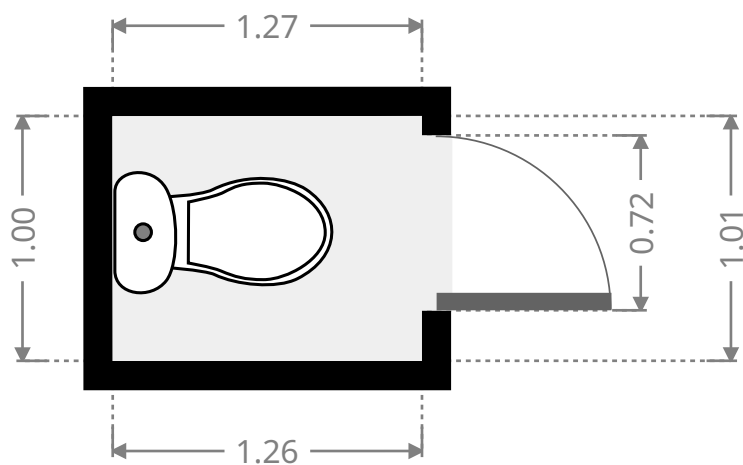
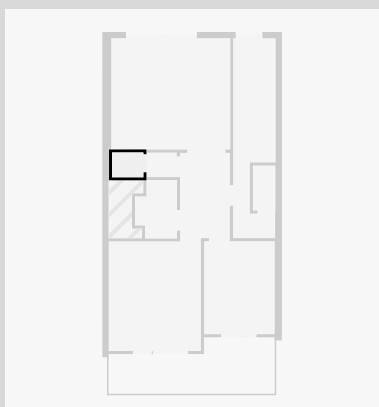

# Rêvimmo - 3794660

## App 1 Salle de bains

Largeur 1.70 m  
Longeur: 2.37 m  
Superficie 3.50 m<sup>2</sup>  
Périmètre: 8.13 m

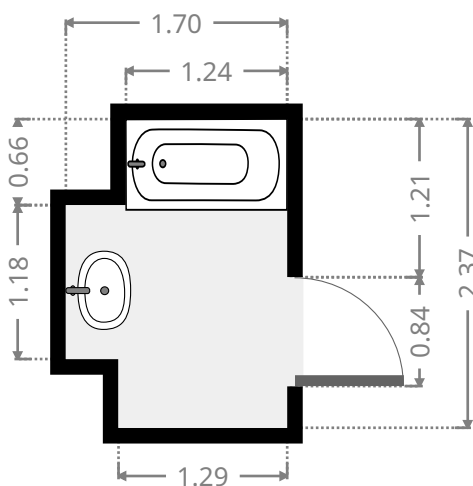
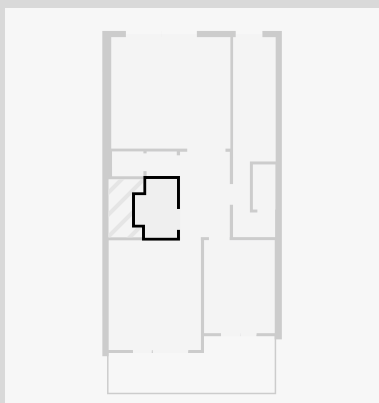

## App 1 Chambre 1

Largeur 3.73 m  
Longeur: 4.44 m  
Superficie 16.55 m<sup>2</sup>  
Périmètre: 16.34 m

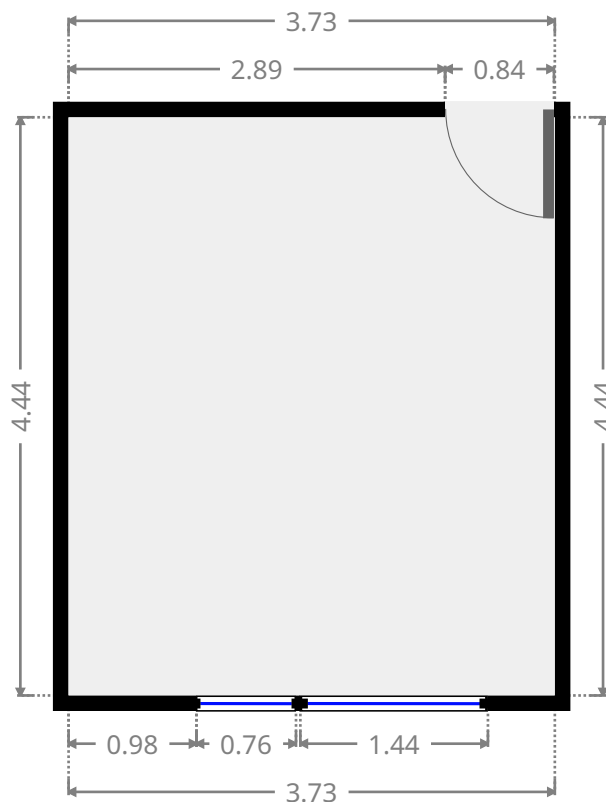
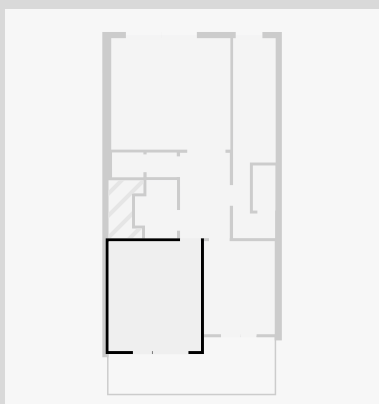

CE PLAN EST FOURNI EN L'ETAT SANS GARANTIE D'AUCUNE SORTE. SENSOPIA N'ACCORDE AUCUNE GARANTIE, Y COMPRIS, SANS S'Y LIMITER, DES GARANTIES QUANT À LA QUALITE ET À LA PRÉCISION DES DIMENSIONS.

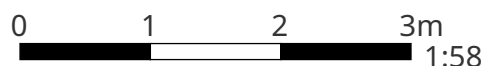

### App 1 Chambre 2

Largeur 2.86 m  
 Longueur: 3.76 m  
 Superficie 10.75 m<sup>2</sup>  
 Périmètre: 13.24 m

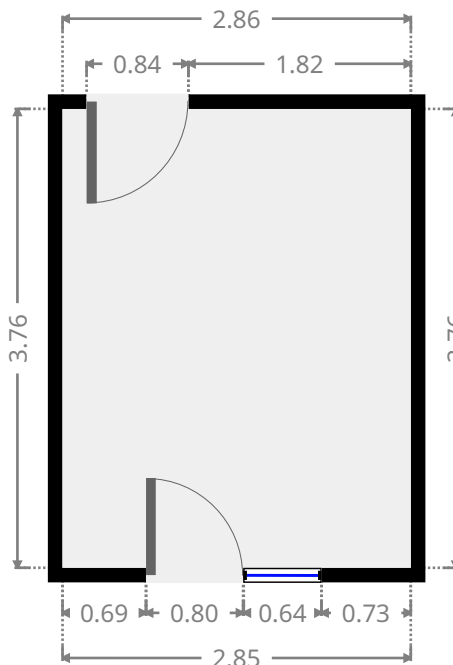
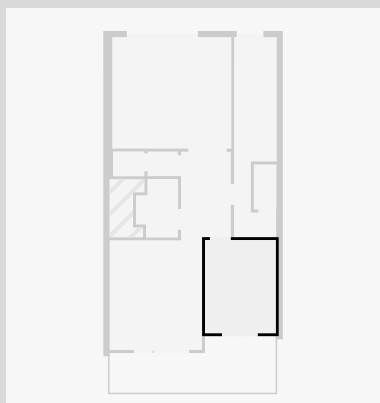

### App 1 Terrasse

Largeur 2.29 m  
 Longueur: 6.72 m  
 Superficie 12.76 m<sup>2</sup>  
 Périmètre: 18.02 m

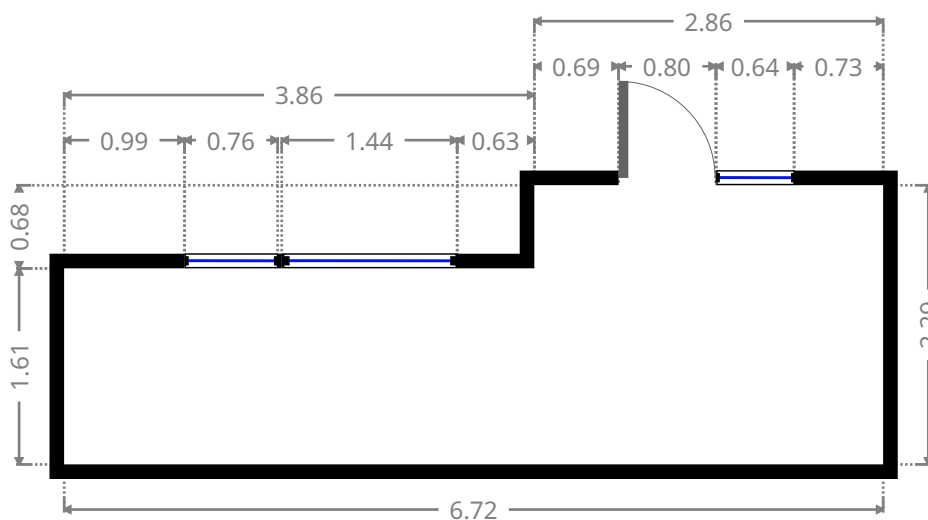
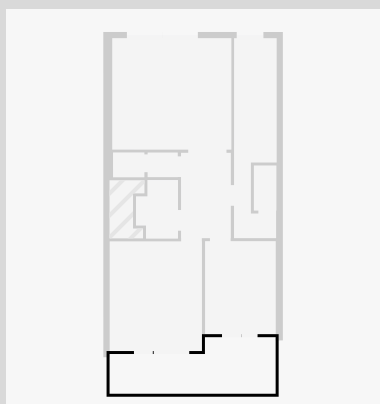

# Rêvimmo - 3794660

## Commun Hall d'entrée

Largeur 1.72 m  
Longeur: 8.09 m  
Superficie 11.76 m<sup>2</sup>  
Périmètre: 21.66 m

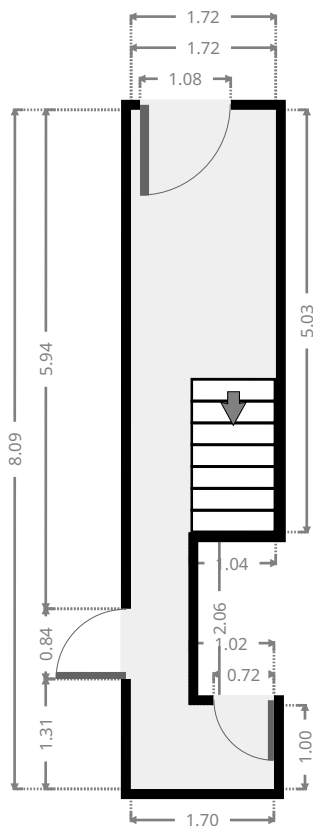
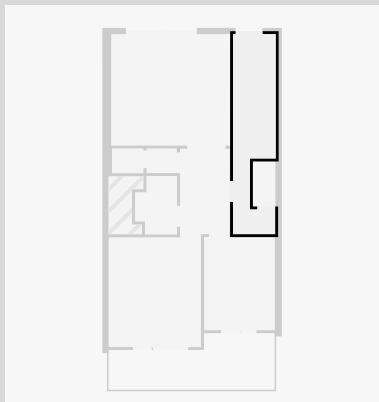

## Commun Escalier

Largeur 0.91 m  
Longeur: 1.82 m  
Superficie 1.66 m<sup>2</sup>  
Périmètre: 5.47 m

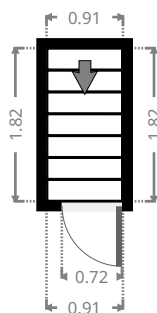
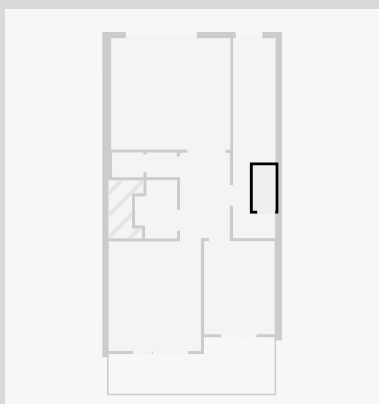

1er étage

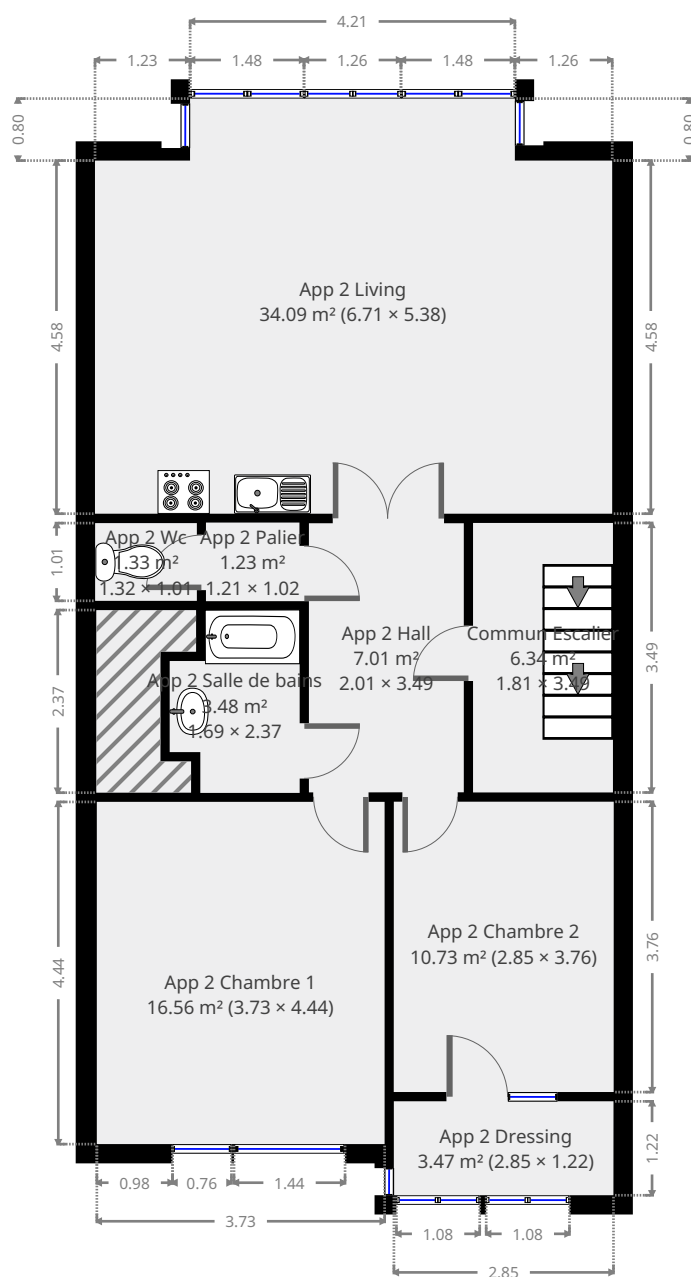

# Rêvimmo - 3794660

## App 2 Living

Largeur 5.38 m  
 Longueur: 6.71 m  
 Superficie 34.09 m<sup>2</sup>  
 Périmètre: 24.18 m

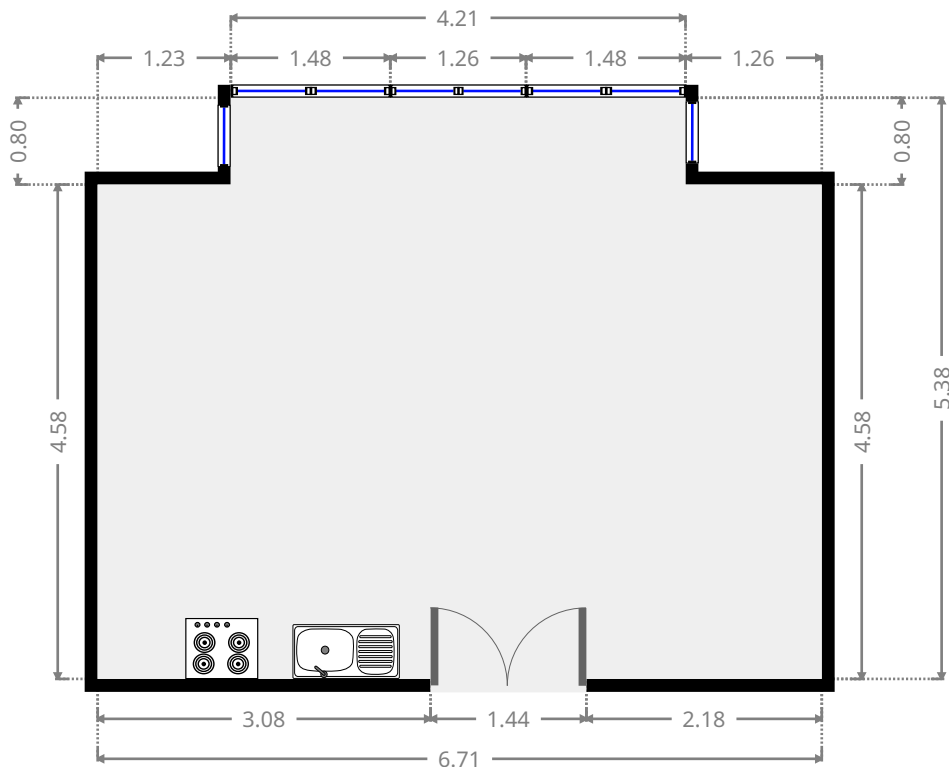
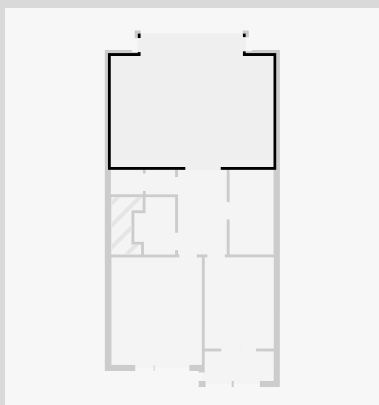

## App 2 Hall

Largeur 2.01 m  
 Longueur: 3.49 m  
 Superficie 7.01 m<sup>2</sup>  
 Périmètre: 10.99 m

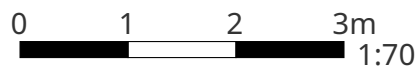
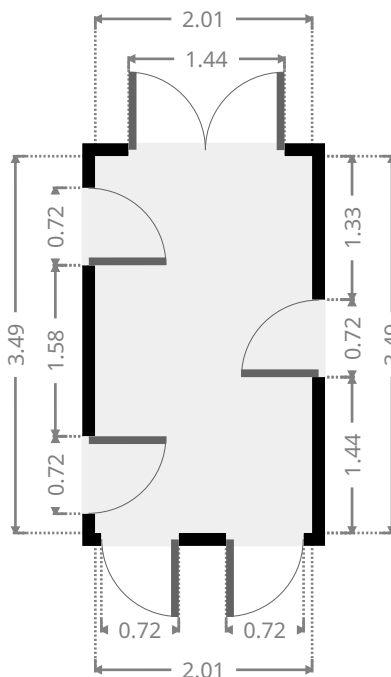
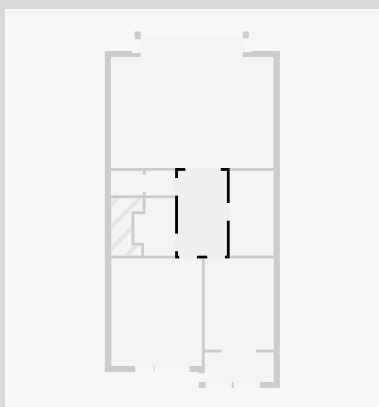

CE PLAN EST FOURNI EN L'ETAT SANS GARANTIE D'AUCUNE SORTE. SENSOPIA N'ACCORDE AUCUNE GARANTIE, Y COMPRIS, SANS S'Y LIMITER, DES GARANTIES QUANT À LA QUALITE ET À LA PRÉCISION DES DIMENSIONS.



# Rêvimmo - 3794660

## App 2 Palier

Largeur 1.02 m  
Longeur: 1.21 m  
Superficie 1.23 m<sup>2</sup>  
Périmètre: 4.46 m

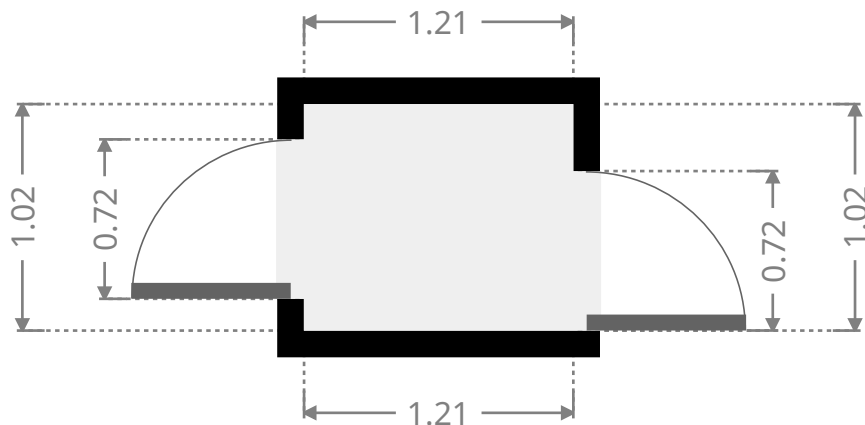
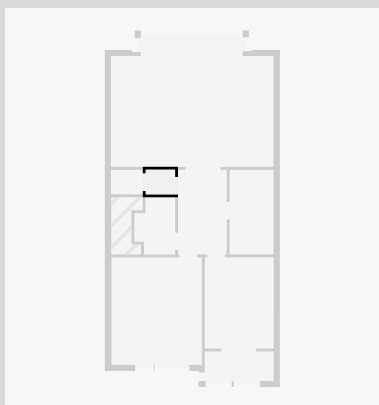

## App 2 Wc

Largeur 1.01 m  
Longeur: 1.32 m  
Superficie 1.33 m<sup>2</sup>  
Périmètre: 4.65 m

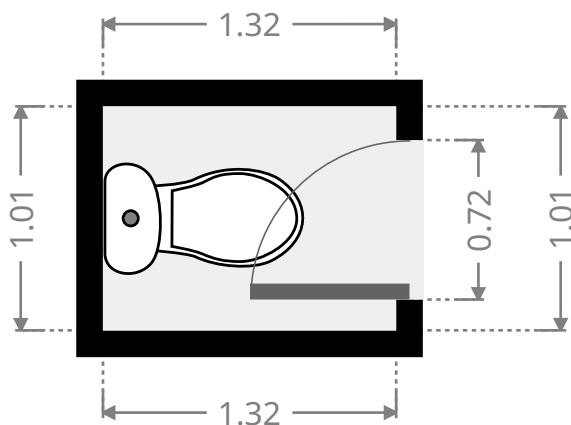
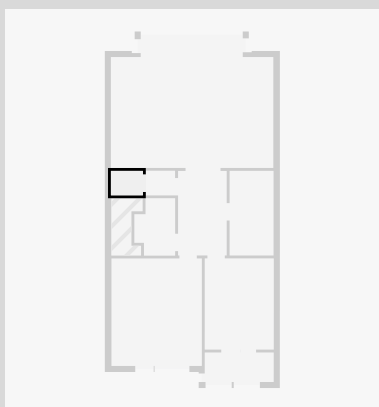

## Révimmo - 3794660

### App 2 Salle de bains

Largeur 1.69 m  
Longeur: 2.37 m  
Superficie 3.48 m<sup>2</sup>  
Périmètre: 8.11 m

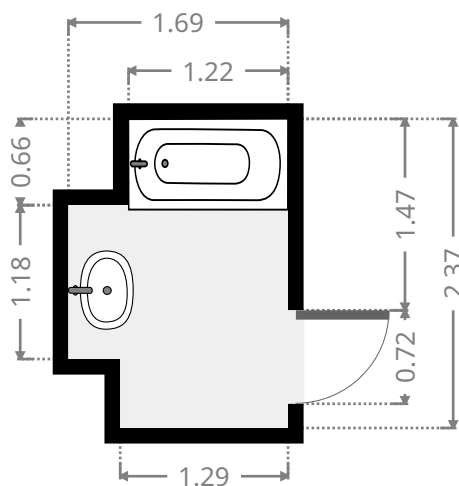
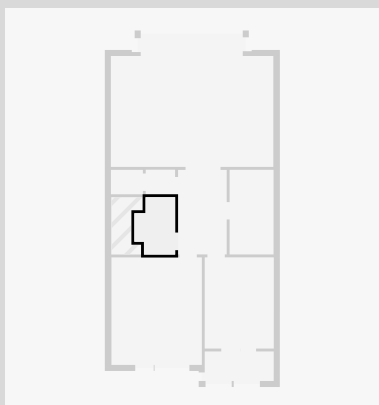

### App 2 Chambre 1

Largeur 3.73 m  
Longeur: 4.44 m  
Superficie 16.56 m<sup>2</sup>  
Périmètre: 16.34 m

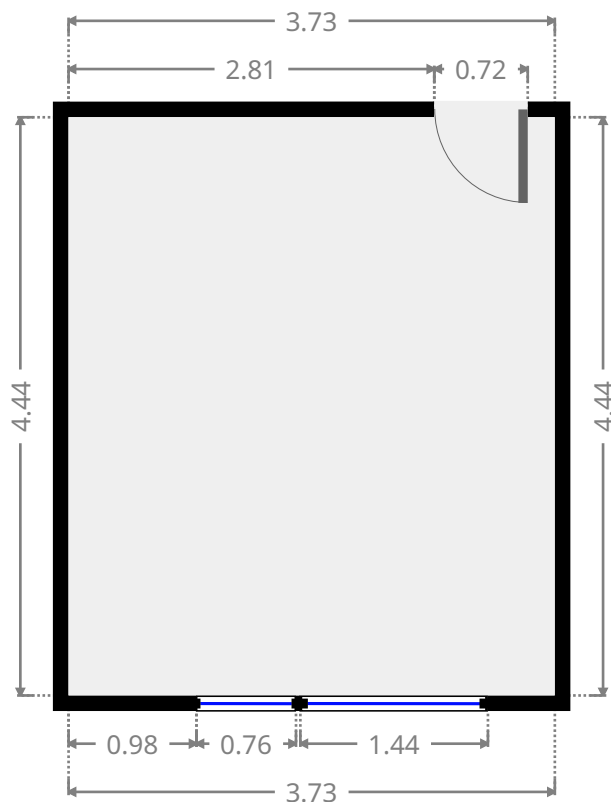
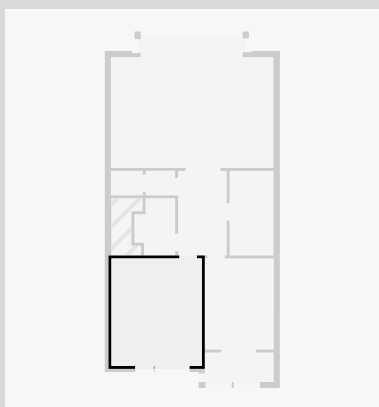

# Rêvimmo - 3794660

## App 2 Chambre 2

Largeur 2.85 m  
Longeur: 3.76 m  
Superficie 10.73 m<sup>2</sup>  
Périmètre: 13.23 m

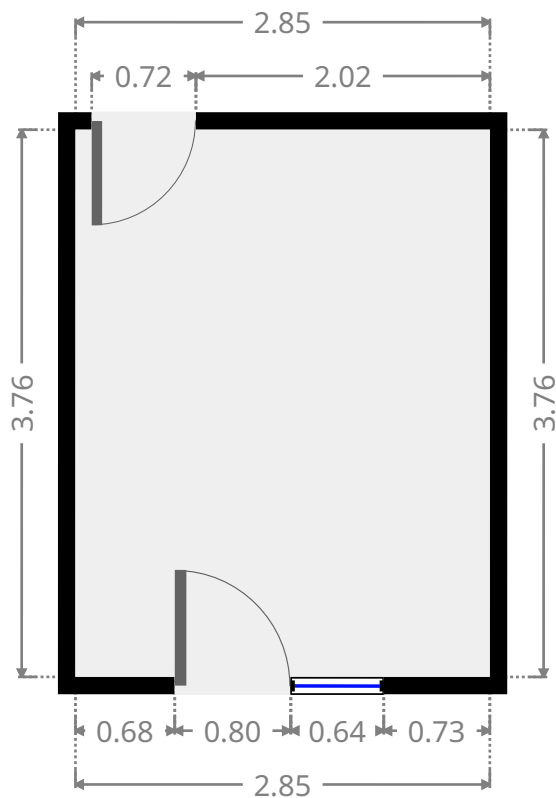
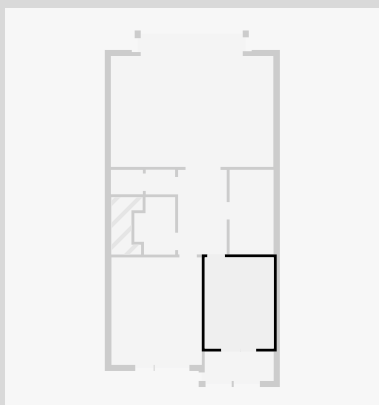

## App 2 Dressing

Largeur 1.22 m  
Longeur: 2.85 m  
Superficie 3.47 m<sup>2</sup>  
Périmètre: 8.13 m

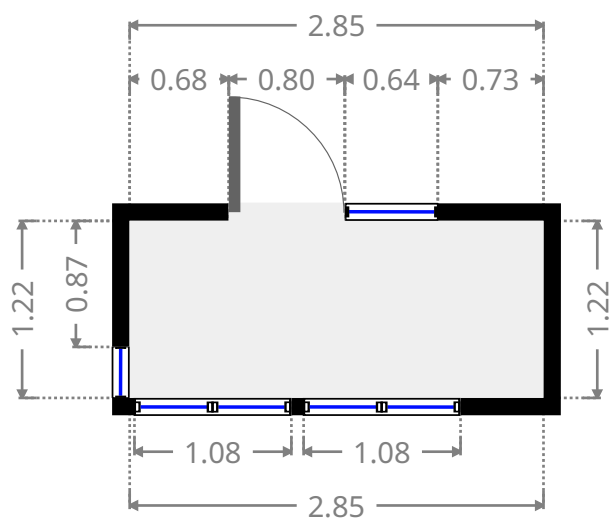
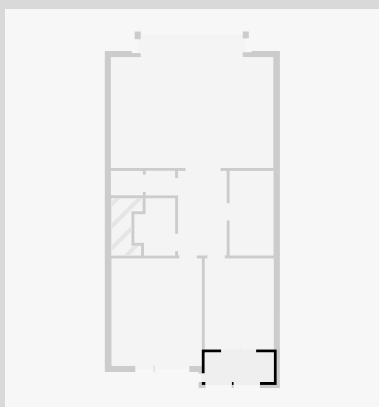

# Rêvimmo - 3794660

## Commun Escalier

Largeur 1.81 m  
Longeur: 3.49 m  
Superficie 6.34 m<sup>2</sup>  
Périmètre: 10.62 m

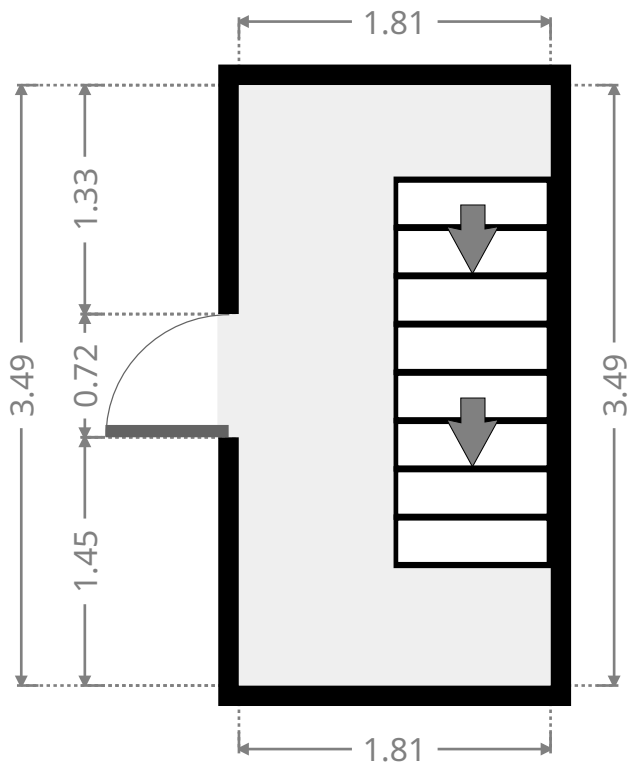
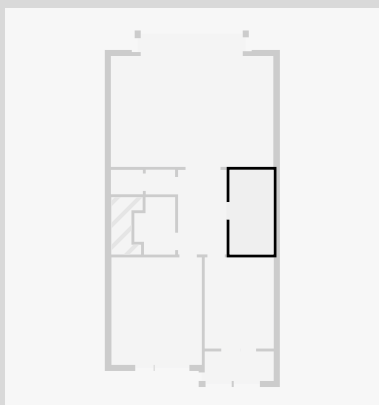

# Révimmo - 3794660

## 3e étage

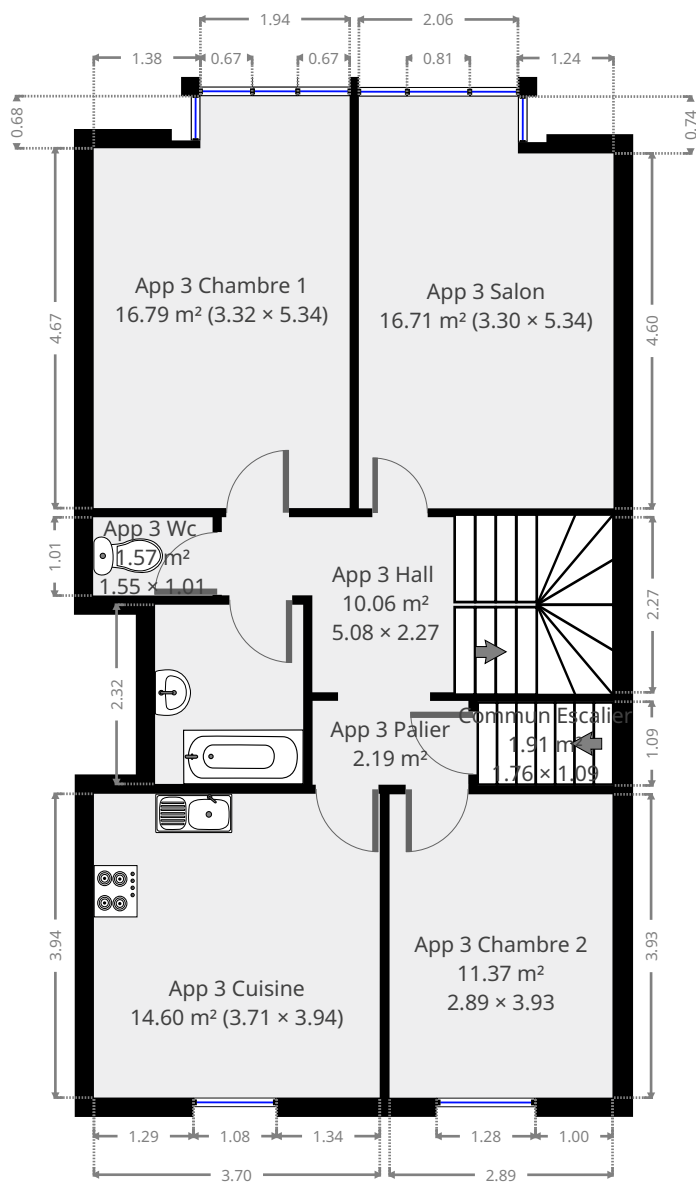

CE PLAN EST FOURNI EN L'ETAT SANS GARANTIE D'AUCUNE SORTE. SENSOPIA N'ACCORDE AUCUNE GARANTIE, Y COMPRIS, SANS S'Y LIMITER, DES GARANTIES QUANT À LA QUALITE ET À LA PRÉCISION DES DIMENSIONS.



# Rêvimmo - 3794660

## App 3 Salon

Largeur 3.30 m  
Longeur: 5.34 m  
Superficie 16.71 m<sup>2</sup>  
Périmètre: 17.28 m

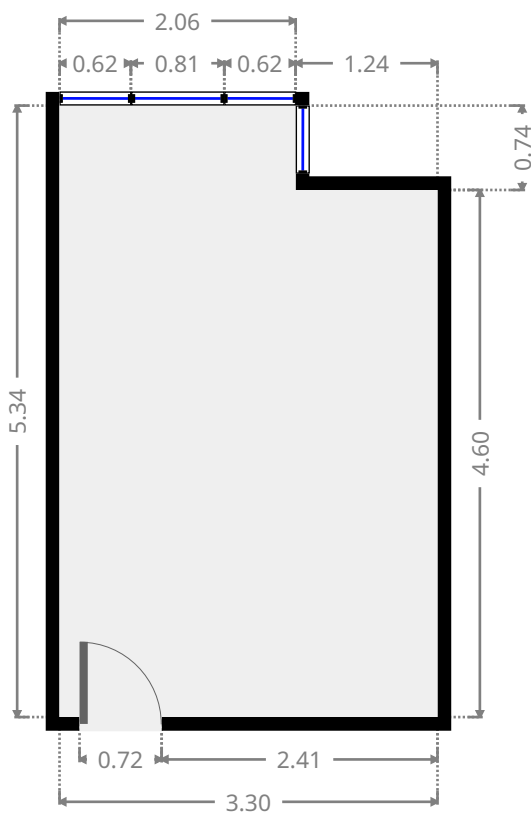
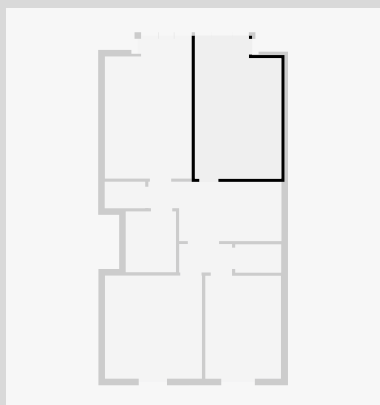

## App 3 Hall

Largeur 2.27 m  
Longeur: 5.08 m  
Superficie 10.06 m<sup>2</sup>  
Périmètre: 14.71 m

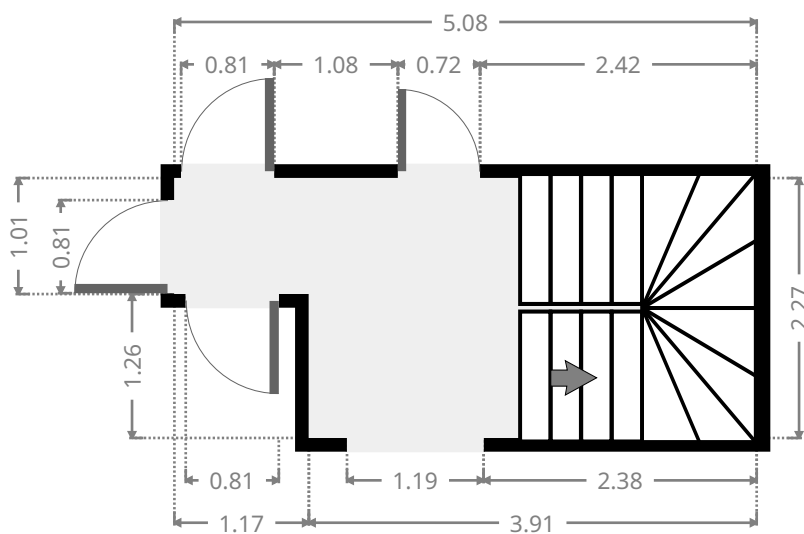
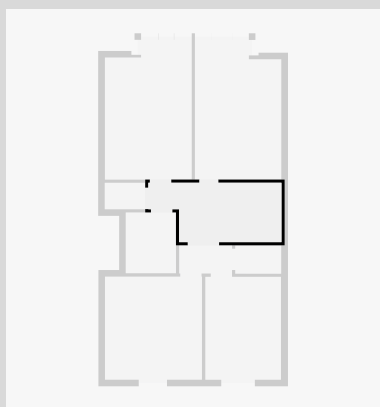

# Rêvimmo - 3794660

## App 3 Chambre 1

Largeur 3.32 m  
Longeur: 5.34 m  
Superficie 16.79 m<sup>2</sup>  
Périmètre: 17.32 m

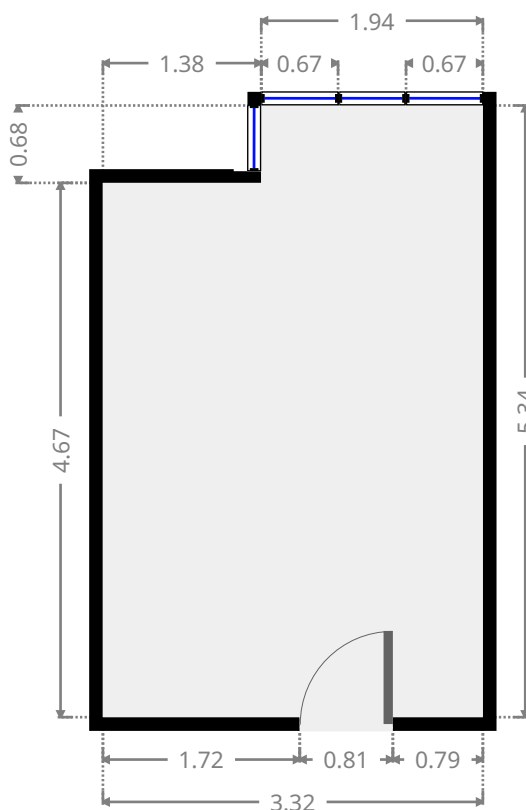
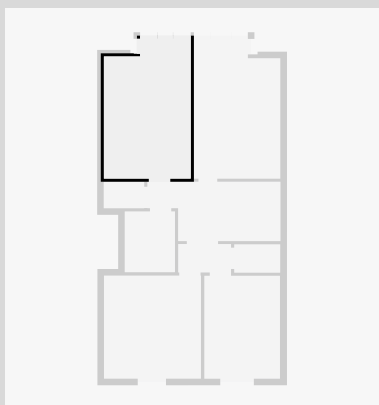

## App 3 Wc

Largeur 1.01 m  
Longeur: 1.55 m  
Superficie 1.57 m<sup>2</sup>  
Périmètre: 5.12 m

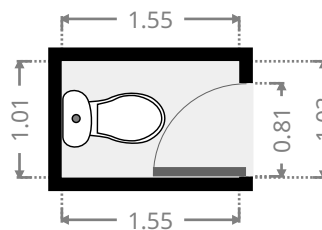
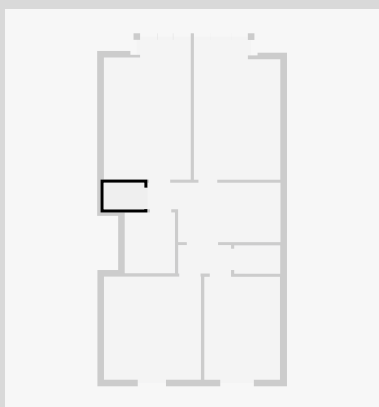

## Rêvimmo - 3794660

### App 3 Salle de bains

Largeur 1.92 m  
Longeur: 2.32 m  
Superficie 4.46 m<sup>2</sup>  
Périmètre: 8.49 m

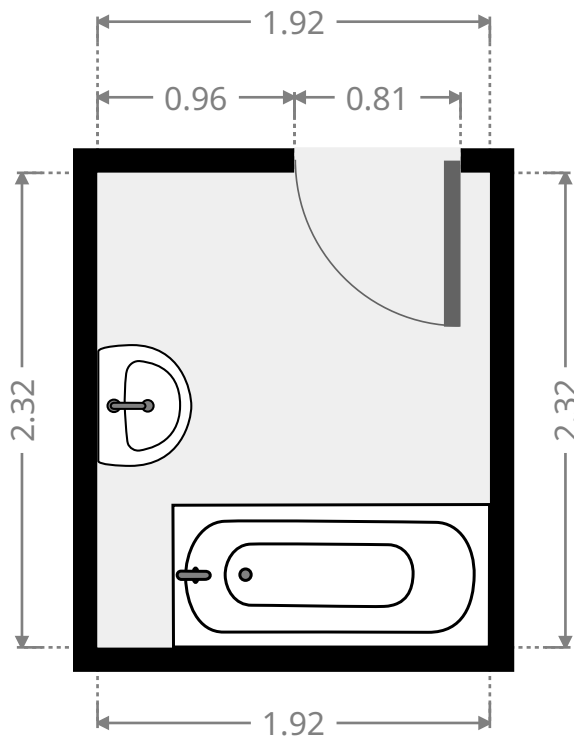
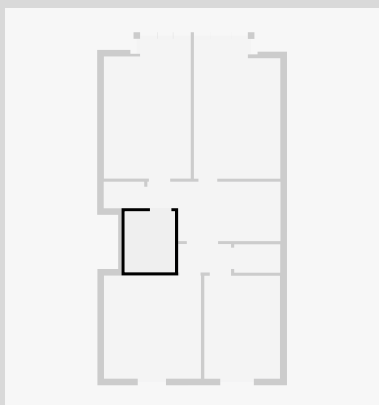

### App 3 Palier

Largeur 1.09 m  
Longeur: 2.02 m  
Superficie 2.19 m<sup>2</sup>  
Périmètre: 6.21 m

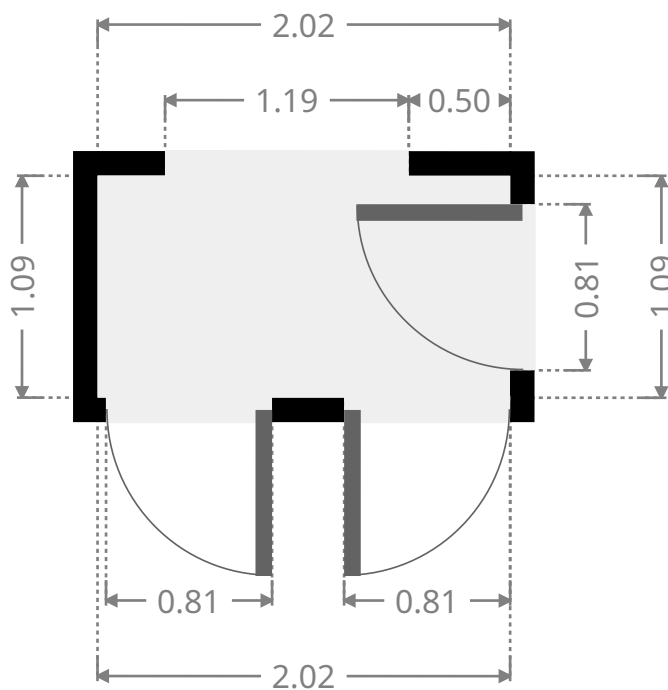
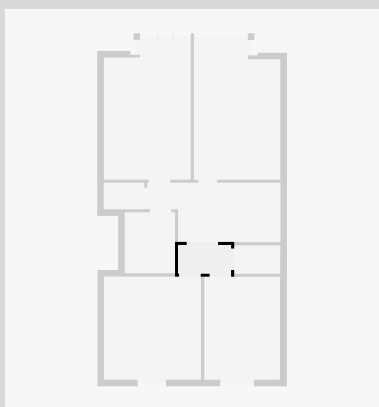



# Rêvimmo - 3794660

## App 3 Chambre 2

Largeur 2.89 m  
Longeur: 3.93 m  
Superficie 11.37 m<sup>2</sup>  
Périmètre: 13.65 m

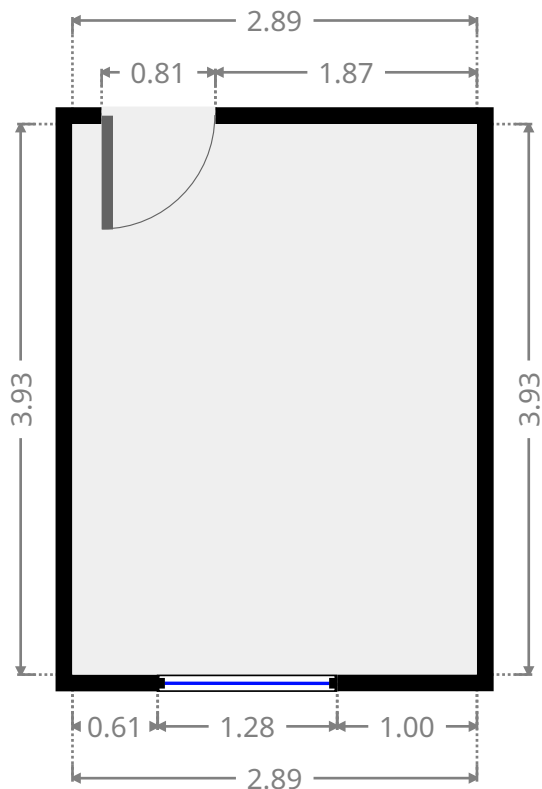
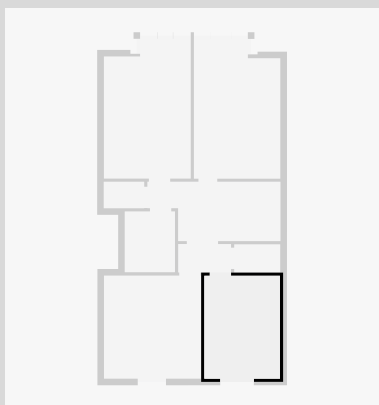

## App 3 Cuisine

Largeur 3.71 m  
Longeur: 3.94 m  
Superficie 14.60 m<sup>2</sup>  
Périmètre: 15.29 m

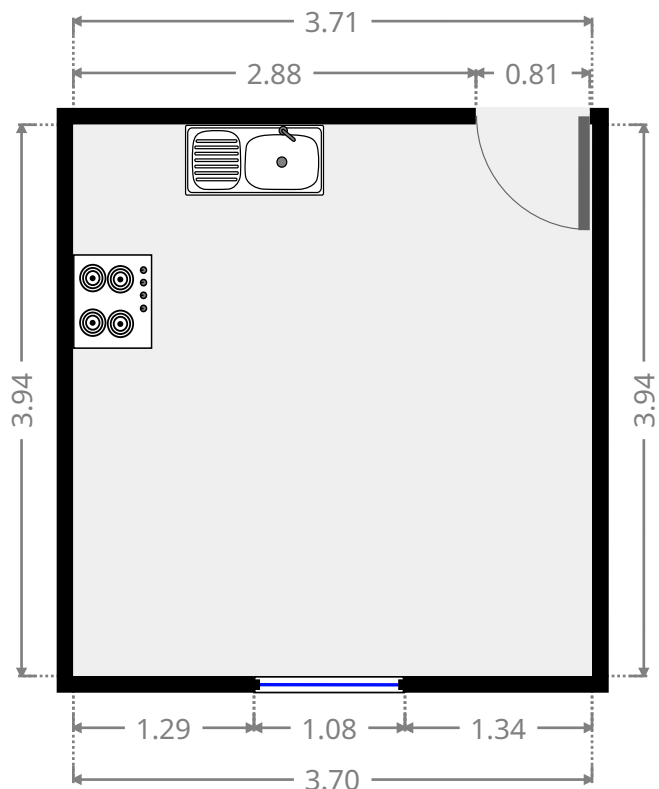
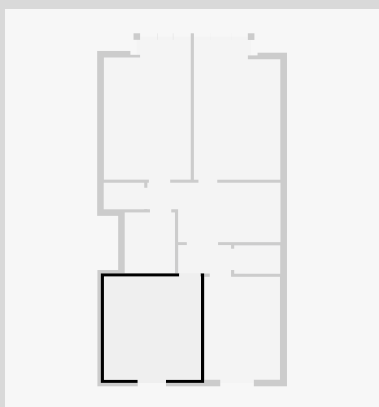

CE PLAN EST FOURNI EN L'ETAT SANS GARANTIE D'AUCUNE SORTE. SENSOPIA N'ACCORDE AUCUNE GARANTIE, Y COMPRIS, SANS S'Y LIMITER, DES GARANTIES QUANT À LA QUALITE ET À LA PRÉCISION DES DIMENSIONS.

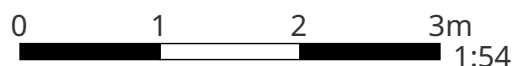

# Rêvimmo - 3794660

## Commun Escalier

Largeur 1.09 m  
Longeur: 1.76 m  
Superficie 1.91 m<sup>2</sup>  
Périmètre: 5.68 m

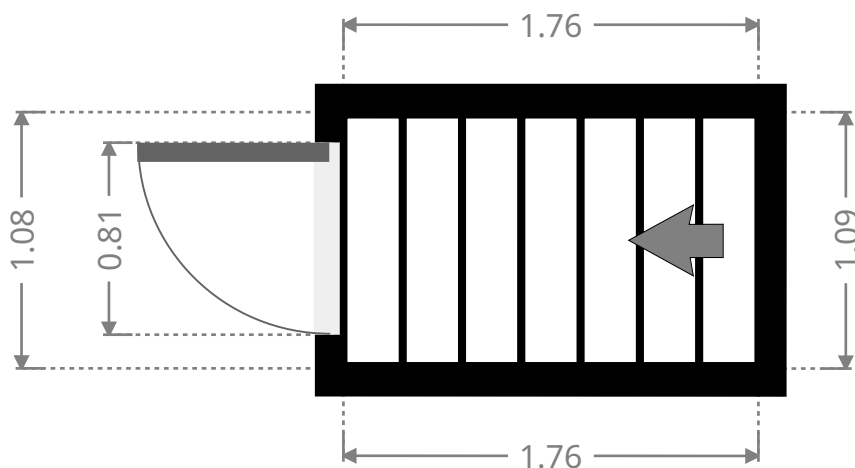
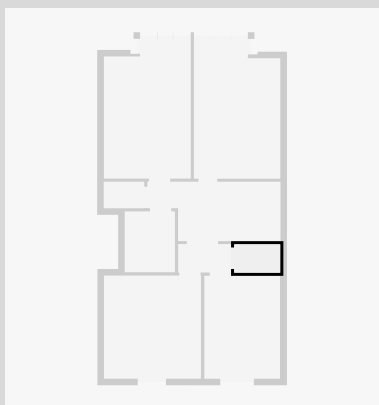

4e étage

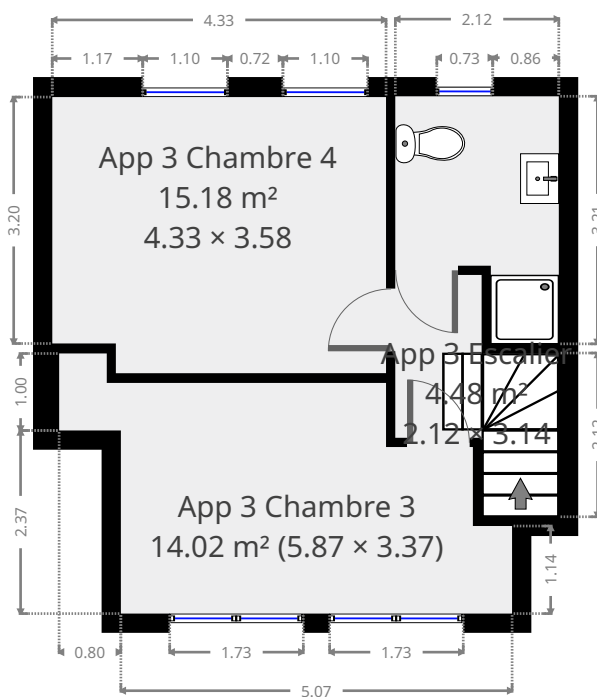

## Révimmo - 3794660

### App 3 Salle de douche

Largeur 2.12 m  
Longueur: 3.21 m  
Superficie 5.55 m<sup>2</sup>  
Périmètre: 10.66 m

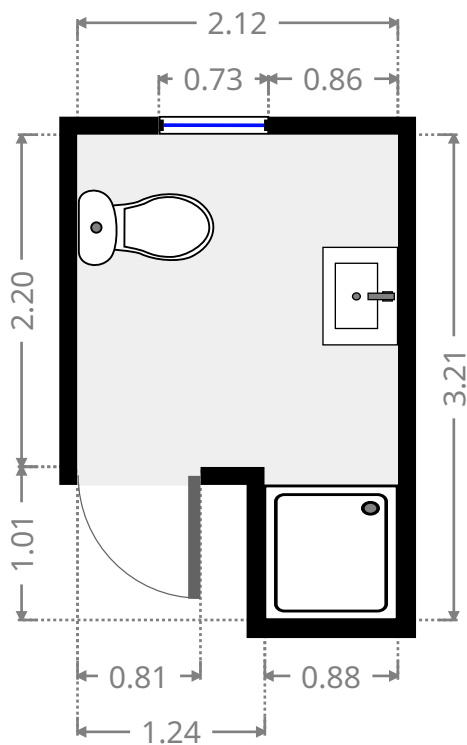
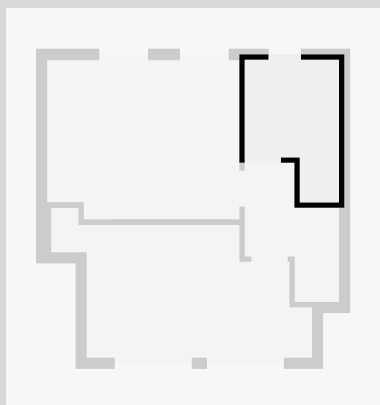

### App 3 Escalier

Largeur 2.12 m  
Longueur: 3.14 m  
Superficie 4.48 m<sup>2</sup>  
Périmètre: 10.51 m

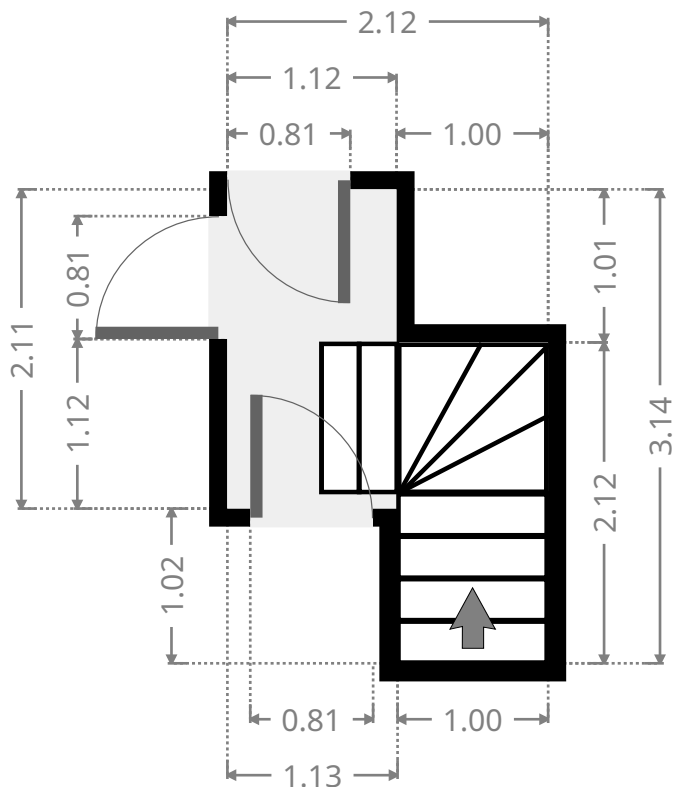
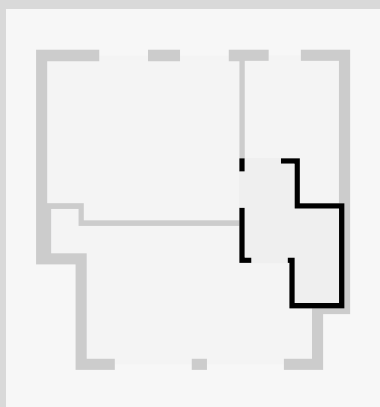

## Rêvimmo - 3794660

### App 3 Chambre 3

Largeur 3.37 m  
Longueur: 5.87 m  
Superficie 14.02 m<sup>2</sup>  
Périmètre: 18.49 m

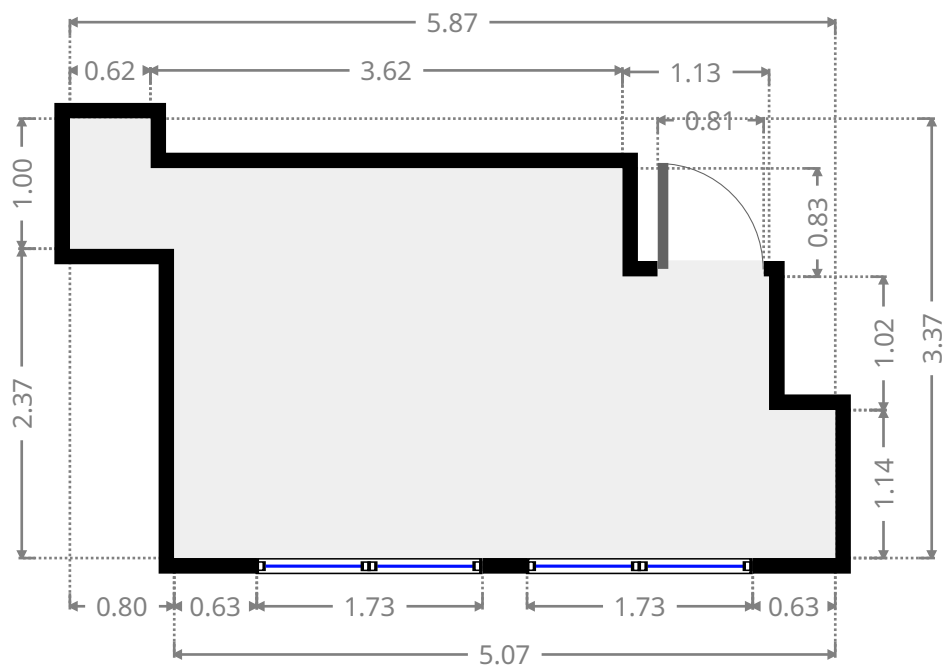
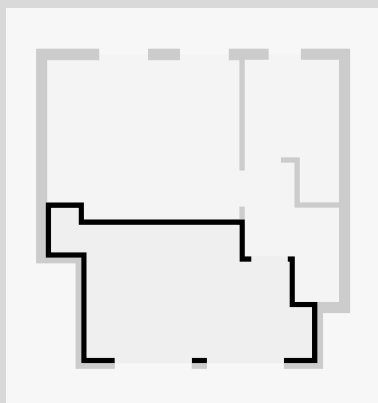

### App 3 Chambre 4

Largeur 3.58 m  
Longueur: 4.33 m  
Superficie 15.18 m<sup>2</sup>  
Périmètre: 15.82 m

