

Rez-de-chaussée

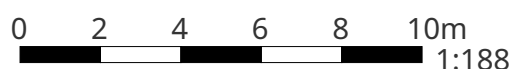
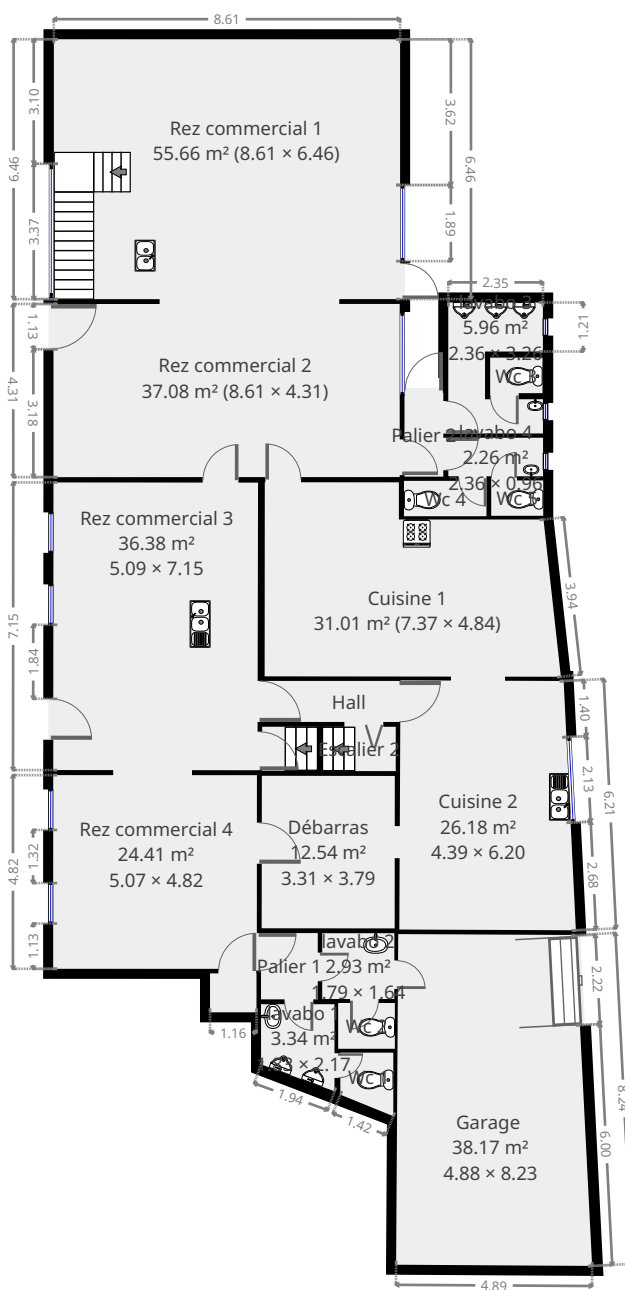

CE PLAN EST FOURNI EN L'ETAT SANS GARANTIE D'AUCUNE MANIÈRE. SENSOPIA N'ACCORDE AUCUNE GARANTIE, Y COMPRIS, SANS S'Y LIMITER, DES GARANTIES QUANT À LA QUALITÉ ET À LA PRÉCISION DES DIMENSIONS.

Rêvimmo - 5749512

Cuisine 2

Largeur 4.39 m
Longeur: 6.20 m
Superficie 26.18 m²
Périmètre: 20.85 m

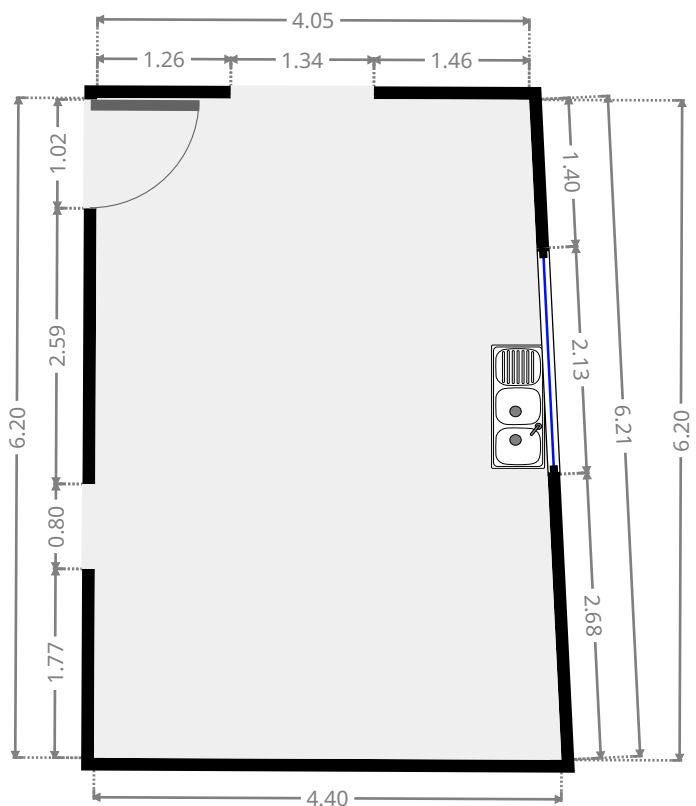
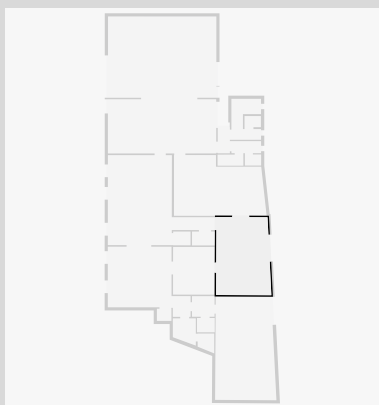

Escalier 1

Largeur 1.09 m
Longeur: 1.38 m
Superficie 1.51 m²
Périmètre: 4.94 m

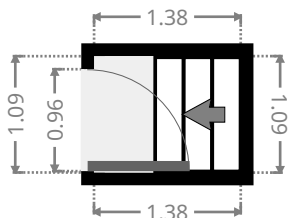
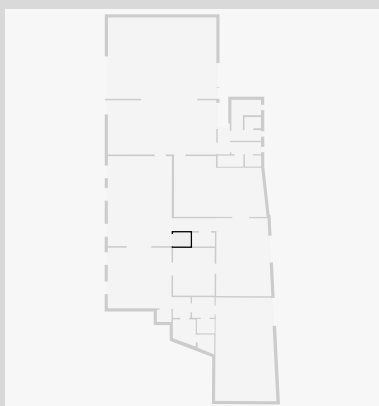

Rêvimmo - 5749512

Wc 5

Largeur 0.88 m
Longeur: 1.29 m
Superficie 1.14 m²
Périmètre: 4.35 m

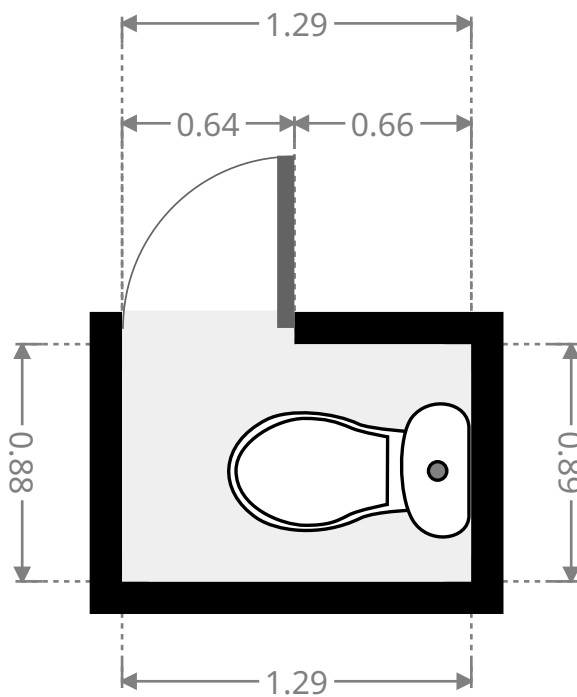
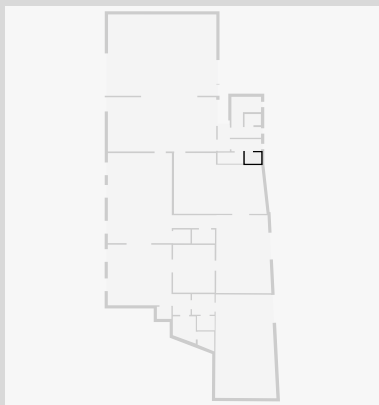

Wc 4

Largeur 0.88 m
Longeur: 2.05 m
Superficie 1.80 m²
Périmètre: 5.86 m

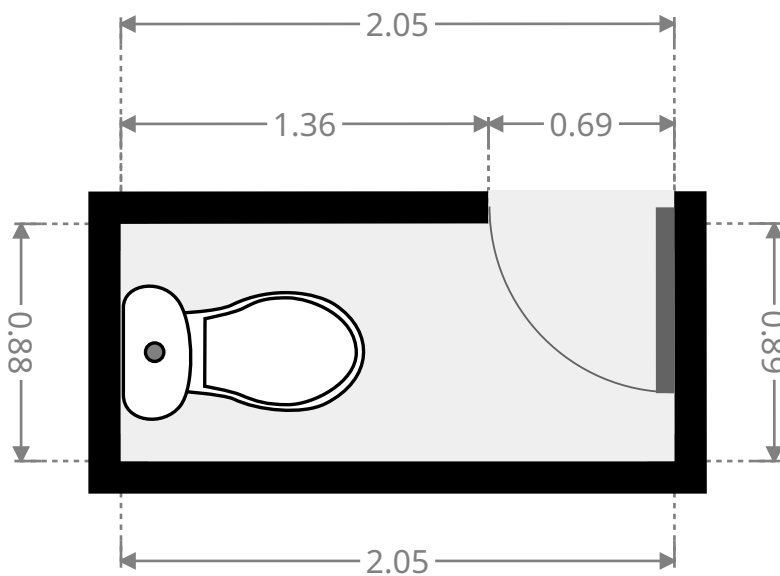
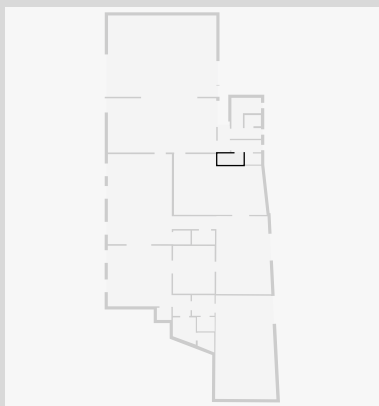

Rêvimmo - 5749512

lavabo 4

Largeur 0.96 m
Longeur: 2.36 m
Superficie 2.26 m²
Périmètre: 6.63 m

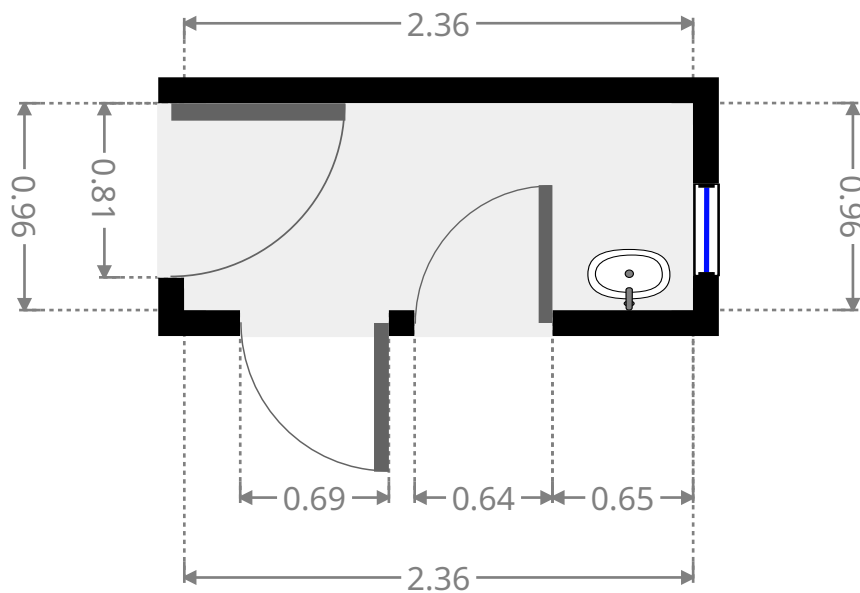
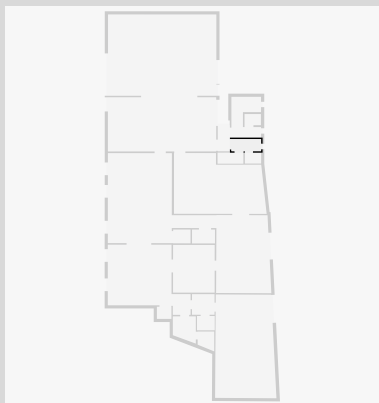

Wc 3

Largeur 0.88 m
Longeur: 1.30 m
Superficie 1.15 m²
Périmètre: 4.37 m

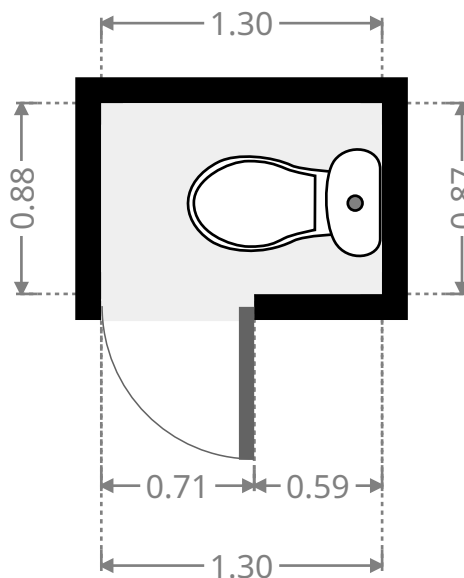
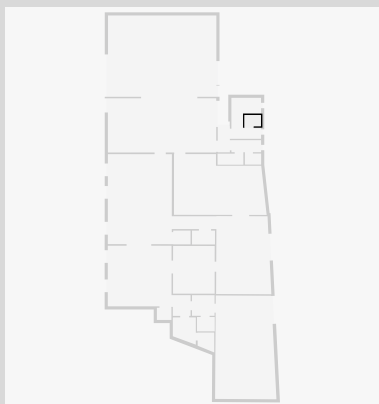

lavabo 3

Largeur 2.36 m
 Longueur: 3.26 m
 Superficie 5.96 m²
 Périmètre: 14.10 m

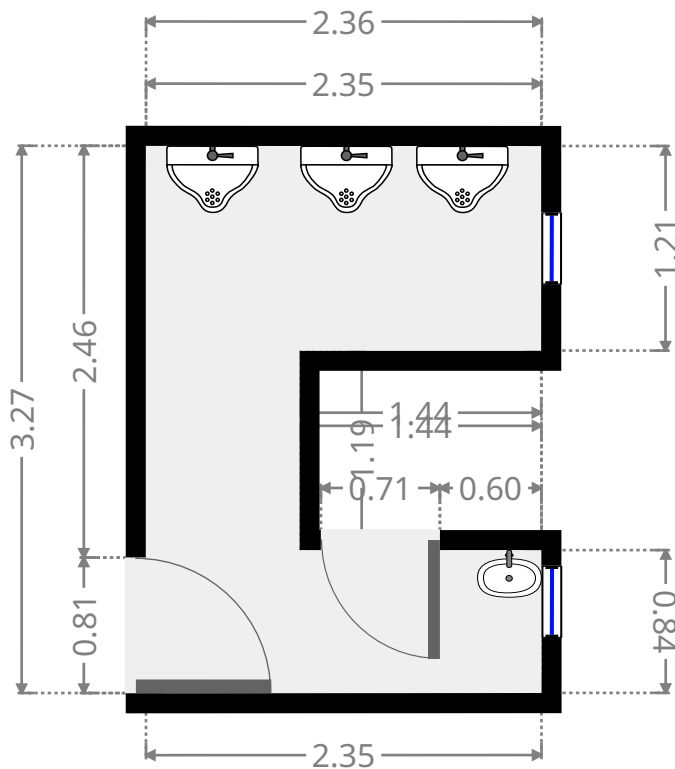
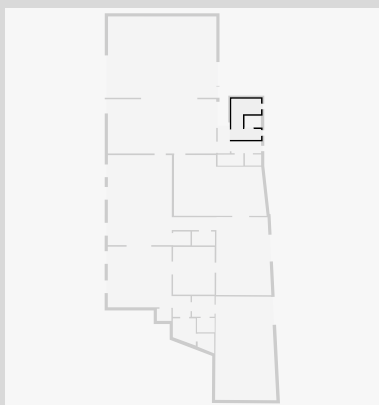

Palier 2

Largeur 0.97 m
 Longueur: 2.08 m
 Superficie 2.01 m²
 Périmètre: 6.09 m

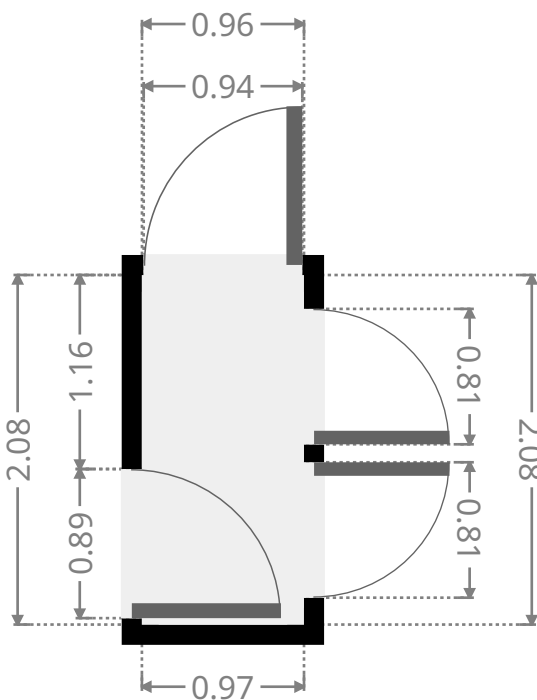
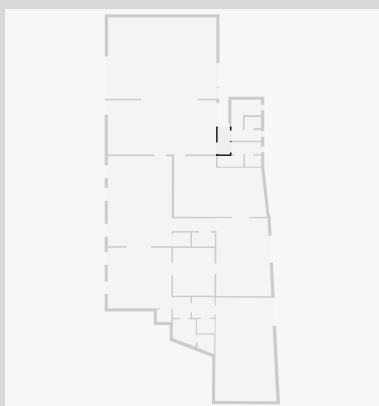

Révimmo - 5749512

Garage

Largeur 4.88 m
Longeur: 8.23 m
Superficie 38.17 m²
Périmètre: 25.74 m

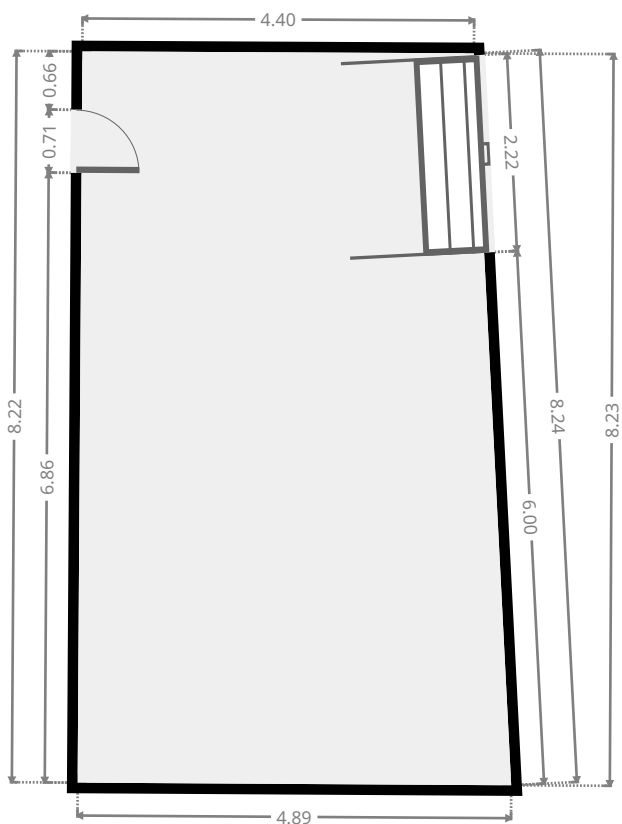
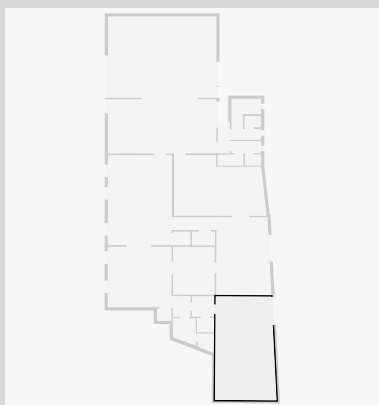

Escalier 2

Largeur 1.10 m
Longeur: 1.82 m
Superficie 2.01 m²
Périmètre: 5.85 m

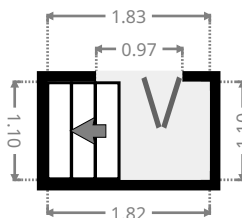
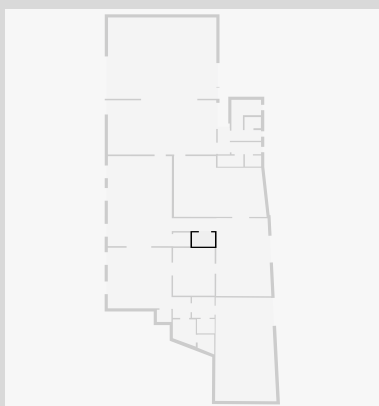

Rêvimmo - 5749512

Hall

Largeur 1.02 m
Longeur: 3.36 m
Superficie 3.43 m²
Périmètre: 8.76 m

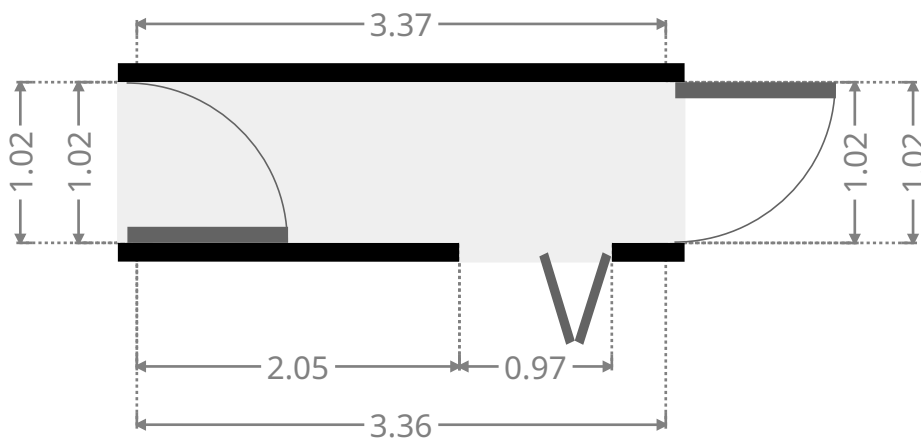
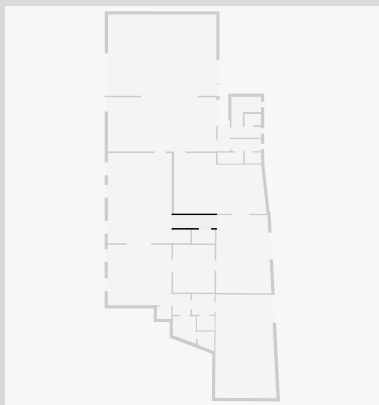

Débarras

Largeur 3.31 m
Longeur: 3.79 m
Superficie 12.54 m²
Périmètre: 14.20 m

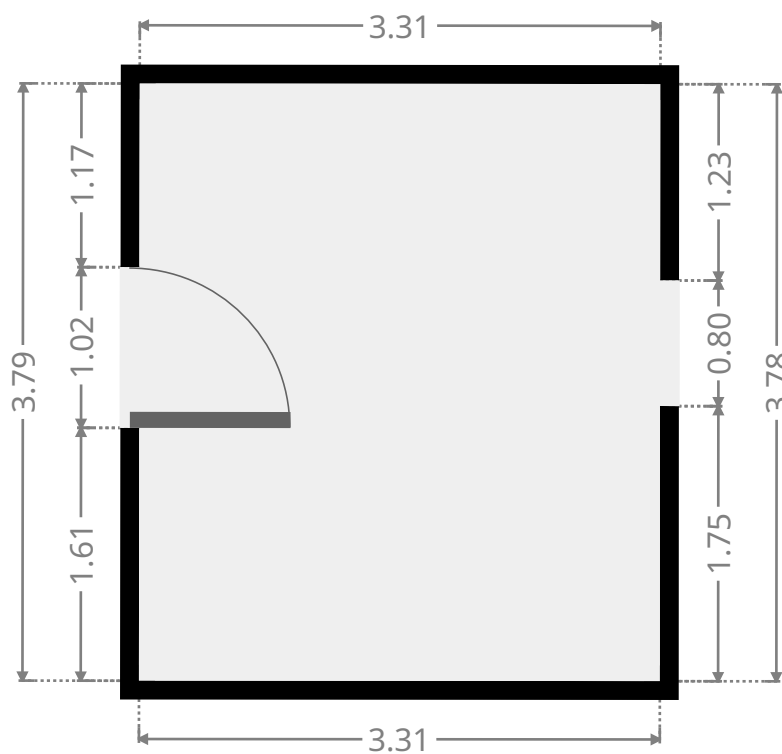
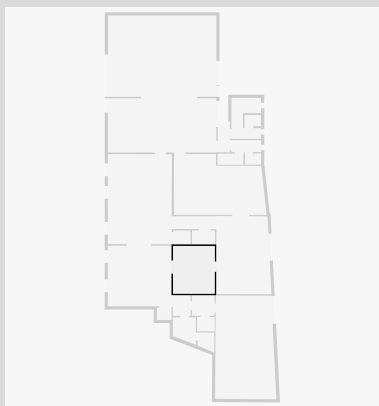

Révimmo - 5749512

Rez commercial 3

Largeur 5.09 m
Longeur: 7.15 m
Superficie 36.38 m²
Périmètre: 24.48 m

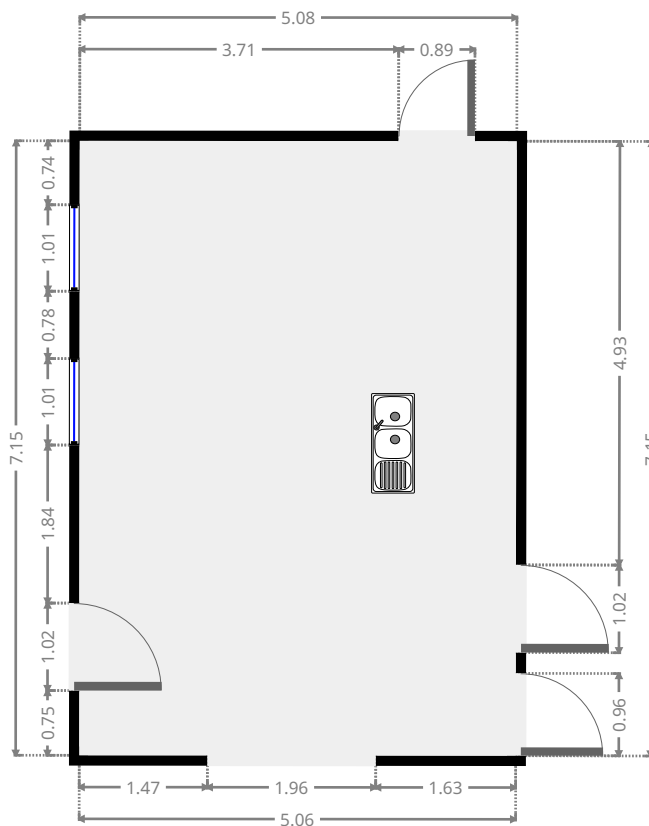
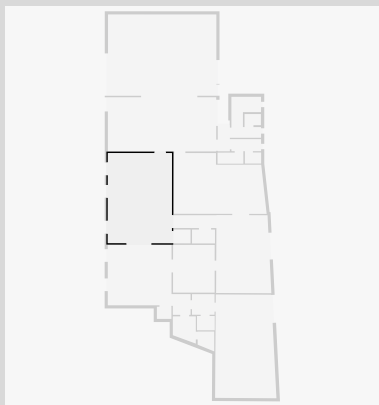

Cuisine 1

Largeur 4.84 m
Longeur: 7.37 m
Superficie 31.01 m²
Périmètre: 23.99 m

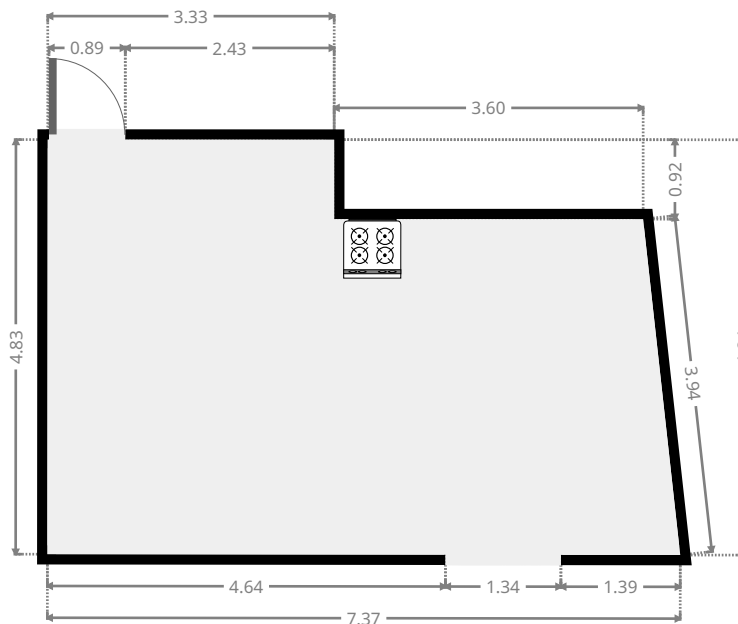
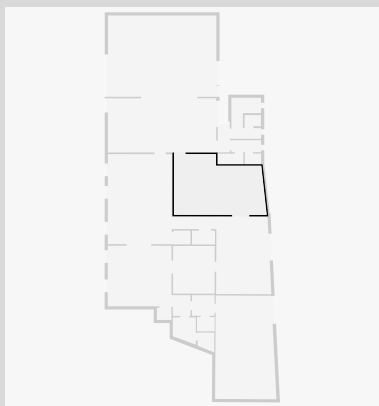

Rêvimmo - 5749512

Rez commercial 1

Largeur 6.46 m
Longeur: 8.61 m
Superficie 55.66 m²
Périmètre: 30.15 m

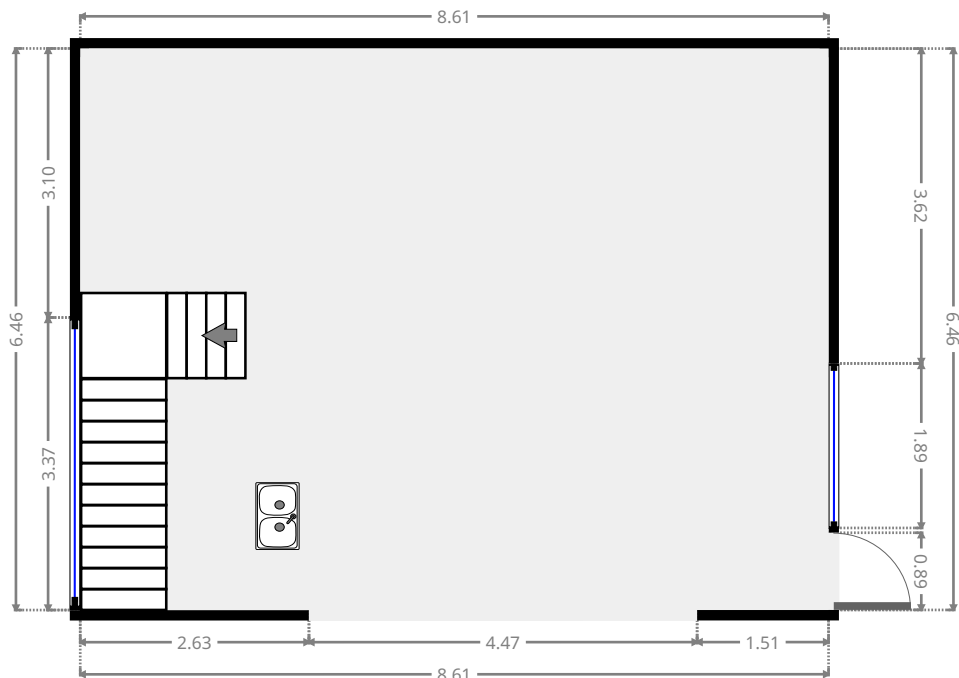
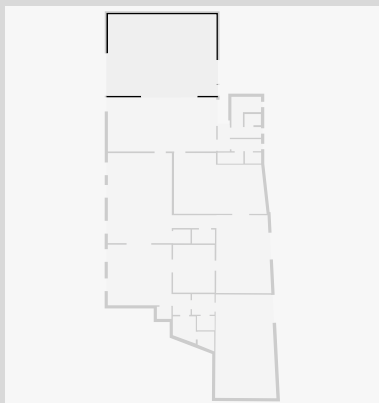

Rez commercial 2

Largeur 4.31 m
Longeur: 8.61 m
Superficie 37.08 m²
Périmètre: 25.84 m

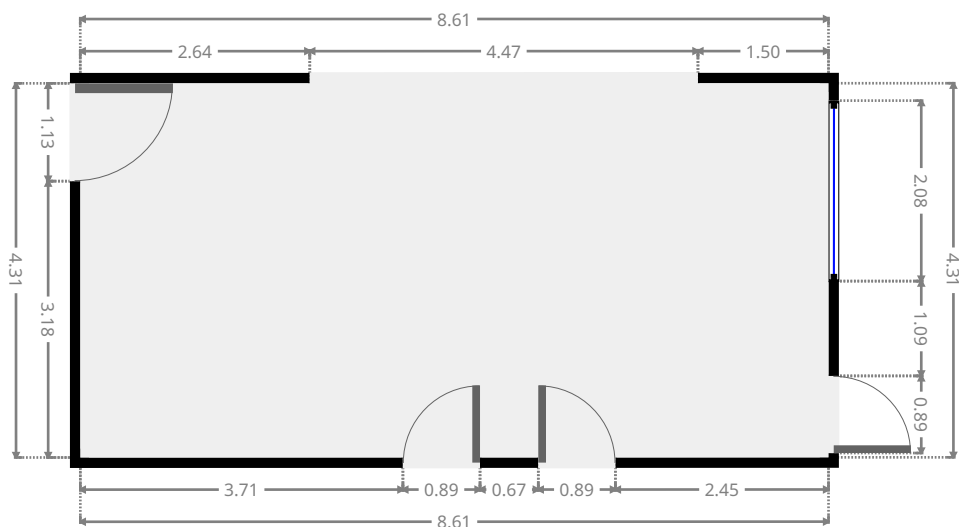
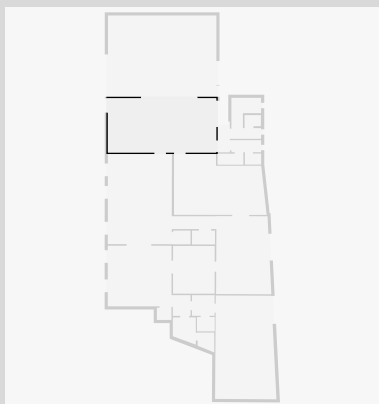

Révimmo - 5749512

Wc 2

Largeur 1.14 m
Longeur: 1.41 m
Superficie 1.60 m²
Périmètre: 5.10 m

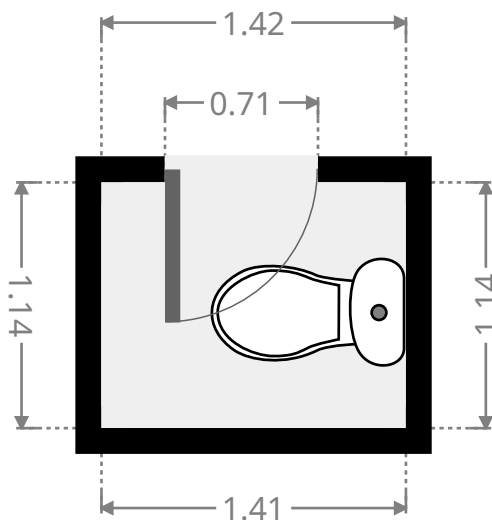
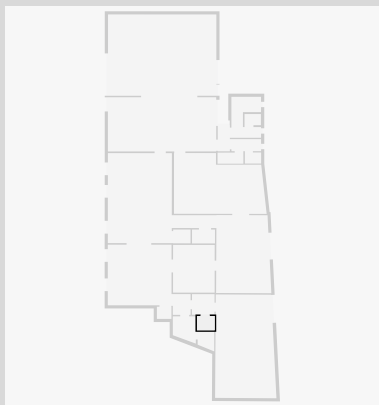

lavabo 2

Largeur 1.64 m
Longeur: 1.79 m
Superficie 2.93 m²
Périmètre: 6.86 m

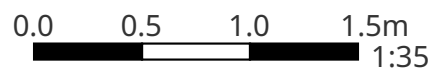
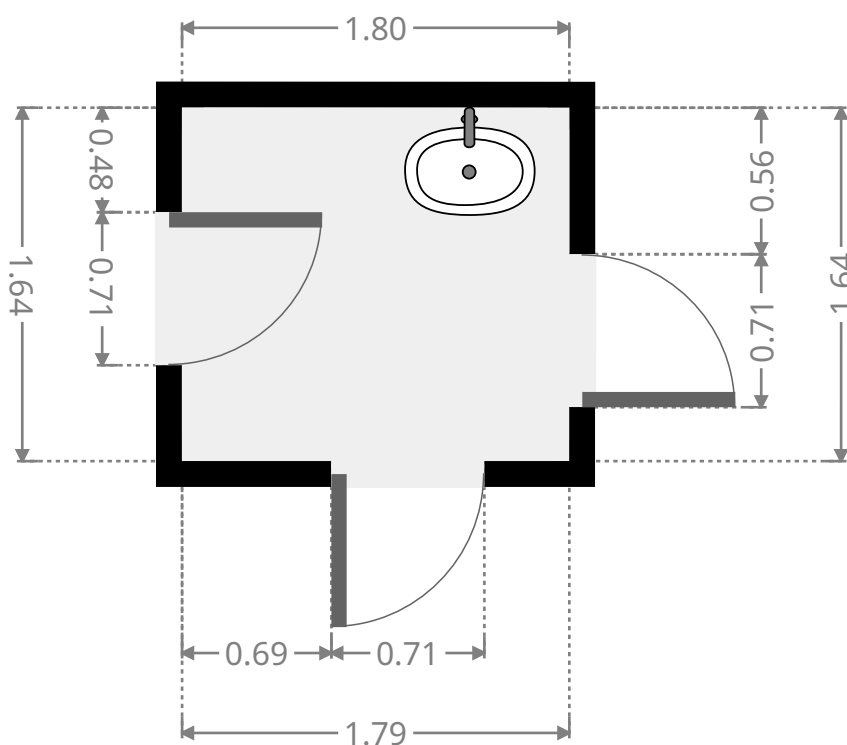
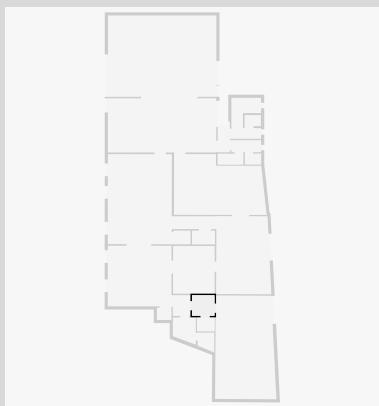

Rêvimmo - 5749512

Wc 1

Largeur 1.32 m
Longeur: 1.58 m
Superficie 1.73 m²
Périmètre: 5.36 m

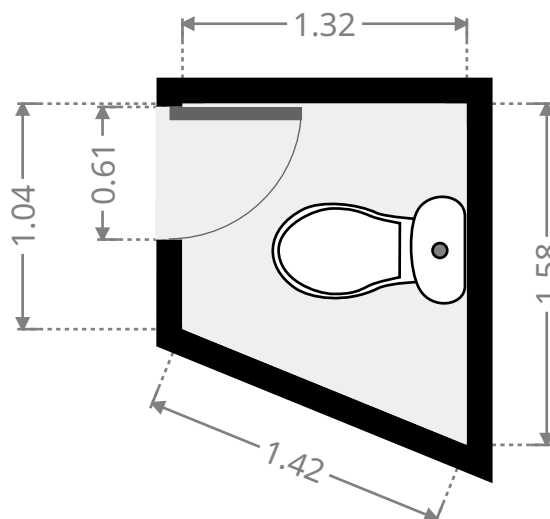
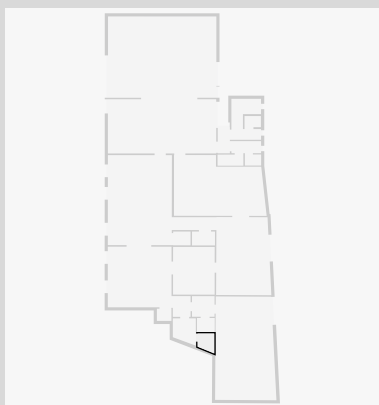

lavabo 1

Largeur 1.83 m
Longeur: 2.17 m
Superficie 3.34 m²
Périmètre: 7.43 m

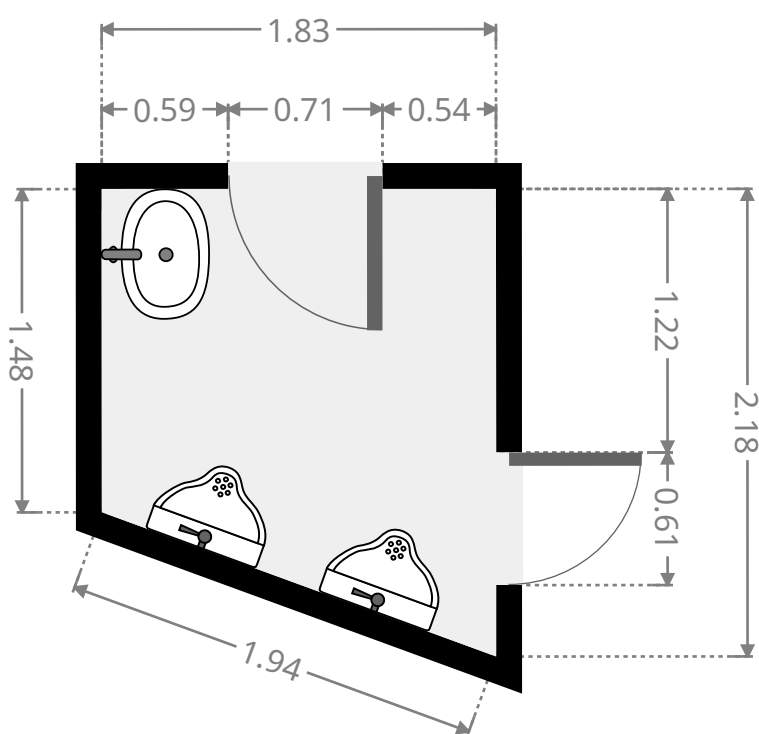
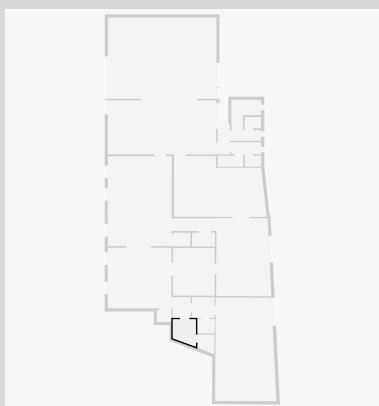

Révimmo - 5749512

Palier 1

Largeur 1.41 m
Longueur: 1.65 m
Superficie 2.33 m²
Périmètre: 6.12 m

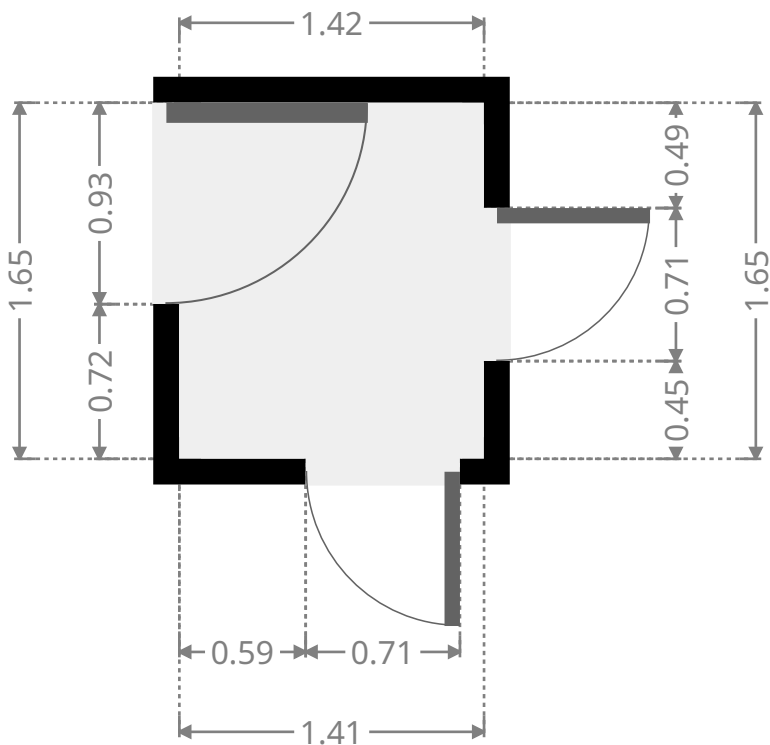
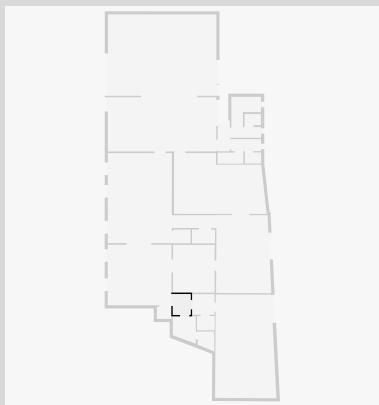

Vestiaire

Largeur 0.97 m
Longueur: 1.16 m
Superficie 1.12 m²
Périmètre: 4.25 m

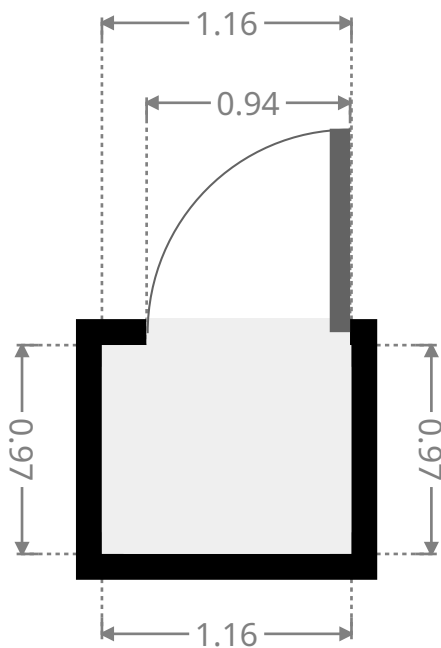
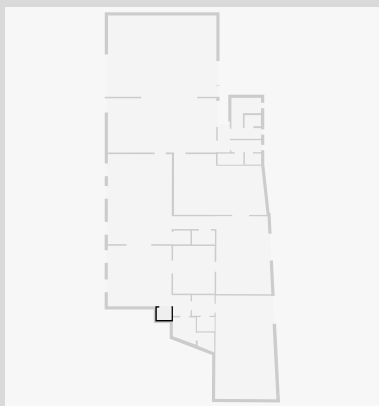

Rêvimmo - 5749512

Rez commercial 4

Largeur 4.82 m
Longeur: 5.07 m
Superficie 24.41 m²
Périmètre: 19.77 m

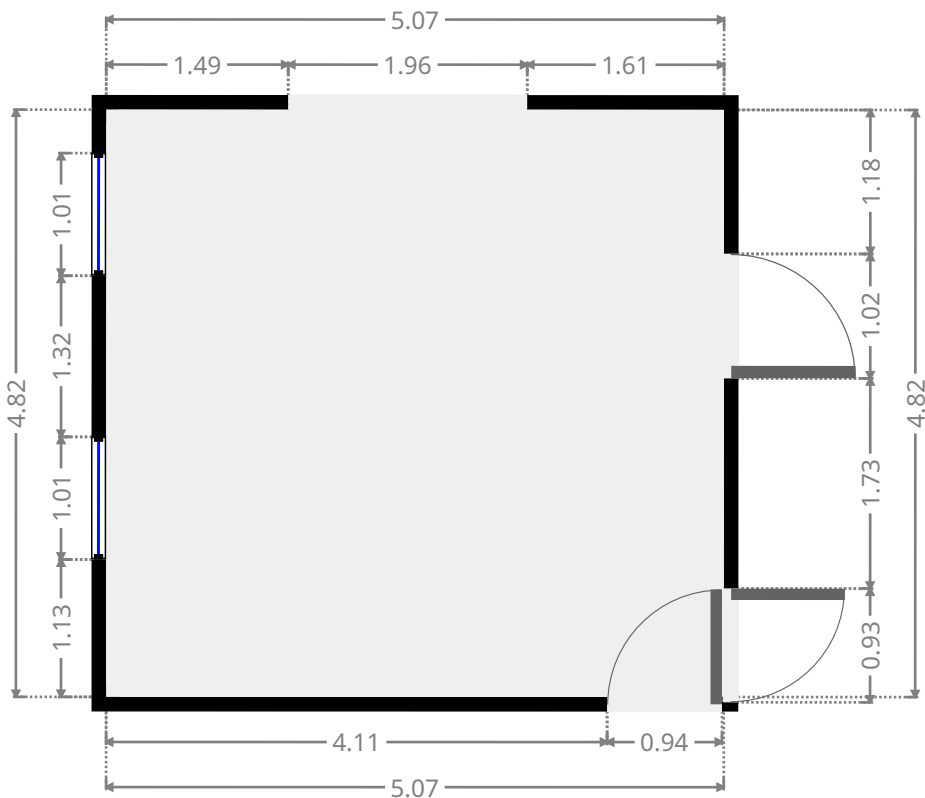
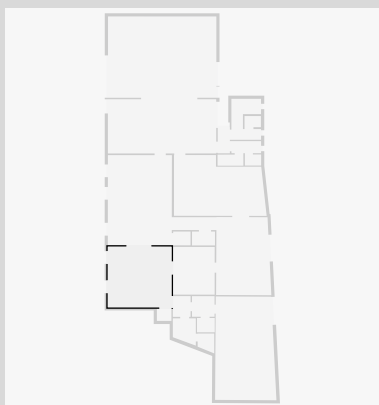

Rêvimmo - 5749512

1er étage

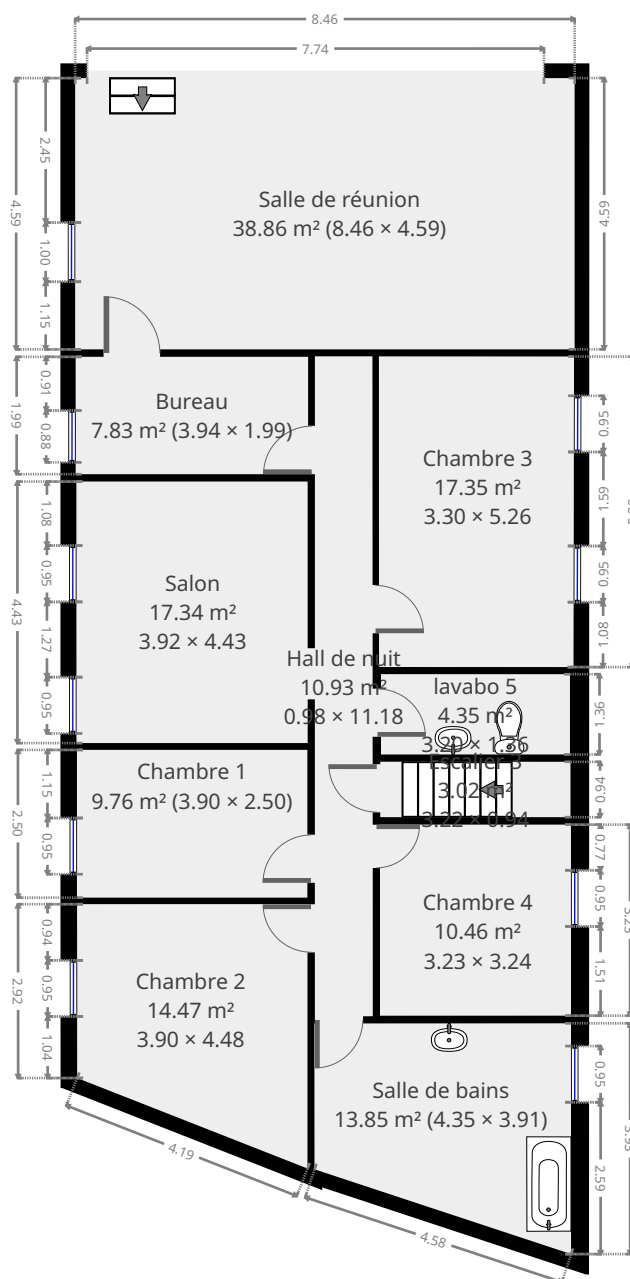

CE PLAN EST FOURNI EN L'ETAT SANS GARANTIE D'AUCUNE SORT. SENSOPIA N'ACCORDE AUCUNE GARANTIE, Y COMPRIS, SANS S'Y LIMITER, DES GARANTIES QUANT À LA QUALITE ET À LA PRÉCISION DES DIMENSIONS.



Révimmo - 5749512

Salle de réunion

Largeur 4.59 m
Longeur: 8.46 m
Superficie 38.86 m²
Périmètre: 26.10 m

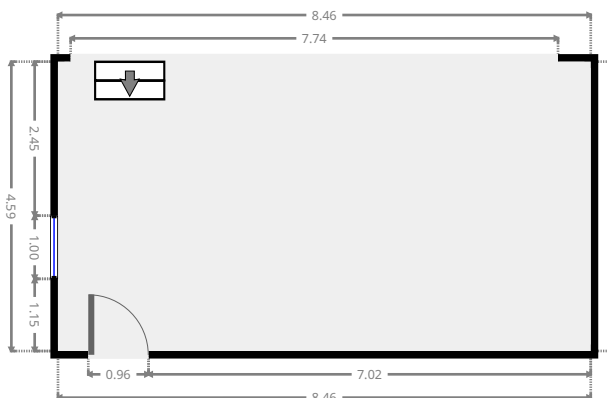
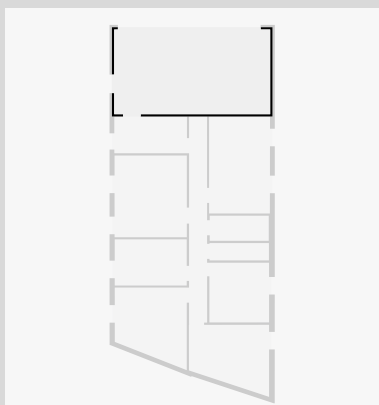

Hall de nuit

Largeur 0.98 m
Longeur: 11.18 m
Superficie 10.93 m²
Périmètre: 24.31 m

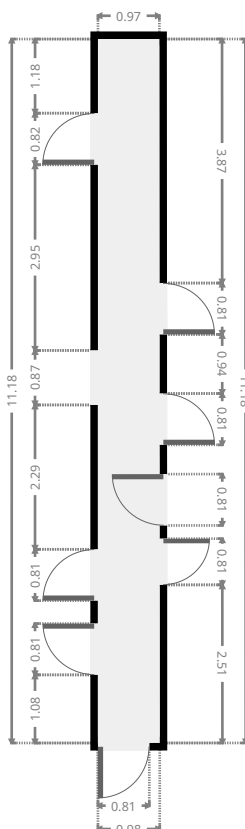
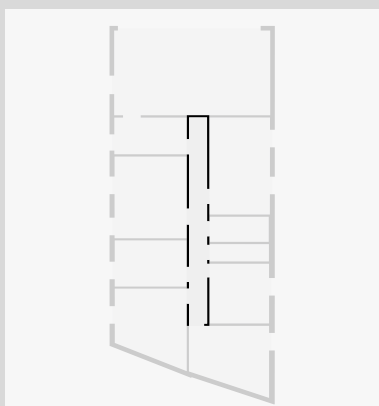

Rêvimmo - 5749512

Bureau

Largeur 1.99 m
Longeur: 3.94 m
Superficie 7.83 m²
Périmètre: 11.85 m

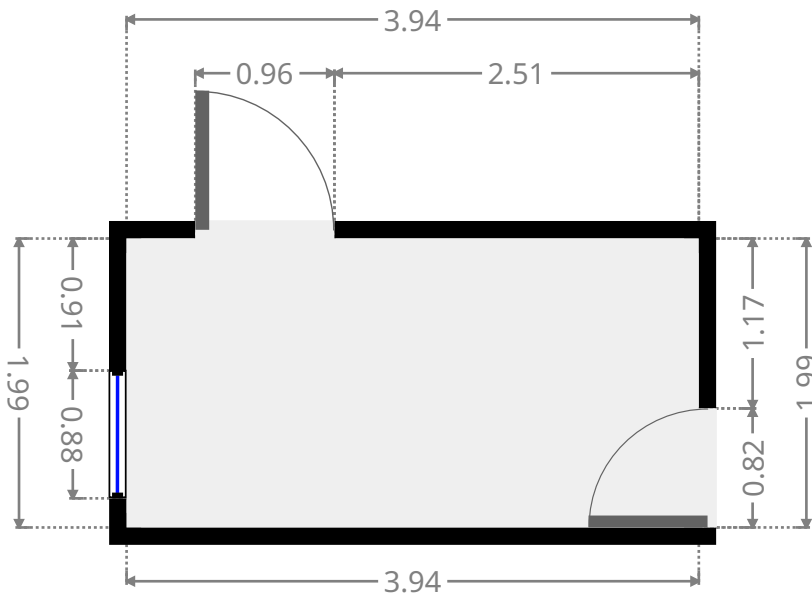
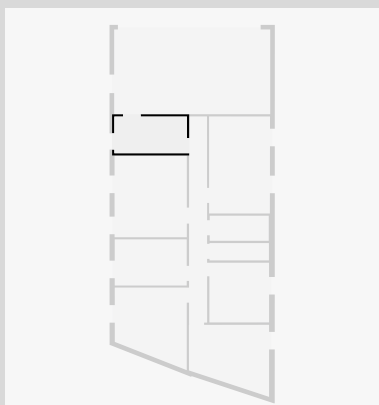

Salon

Largeur 3.92 m
Longeur: 4.43 m
Superficie 17.34 m²
Périmètre: 16.69 m

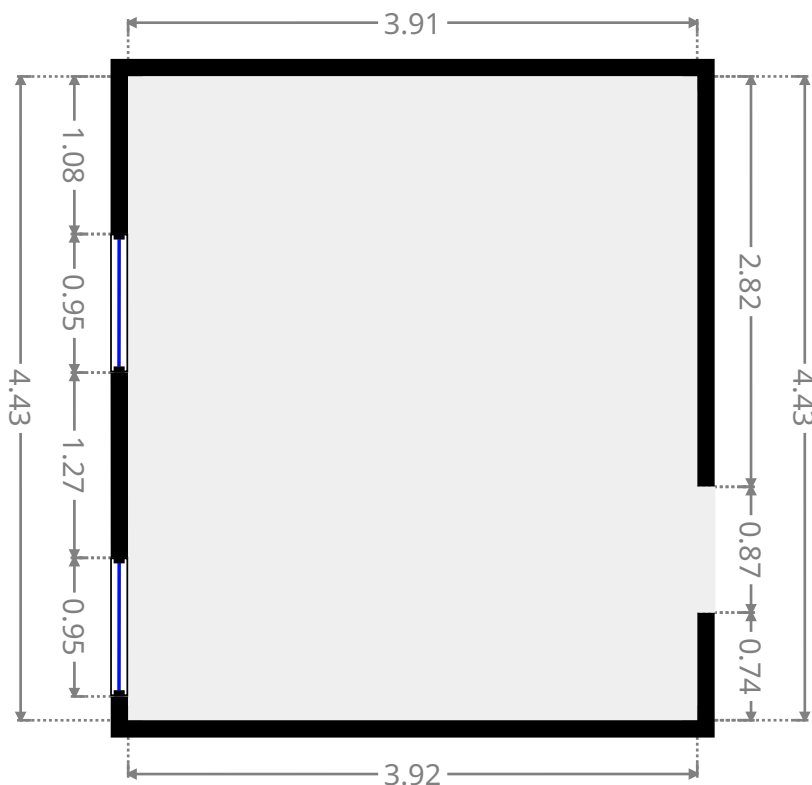
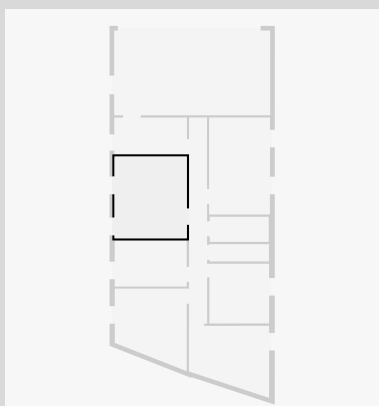

Rêvimmo - 5749512

Chambre 1

Largeur 2.50 m
Longeur: 3.90 m
Superficie 9.76 m²
Périmètre: 12.81 m

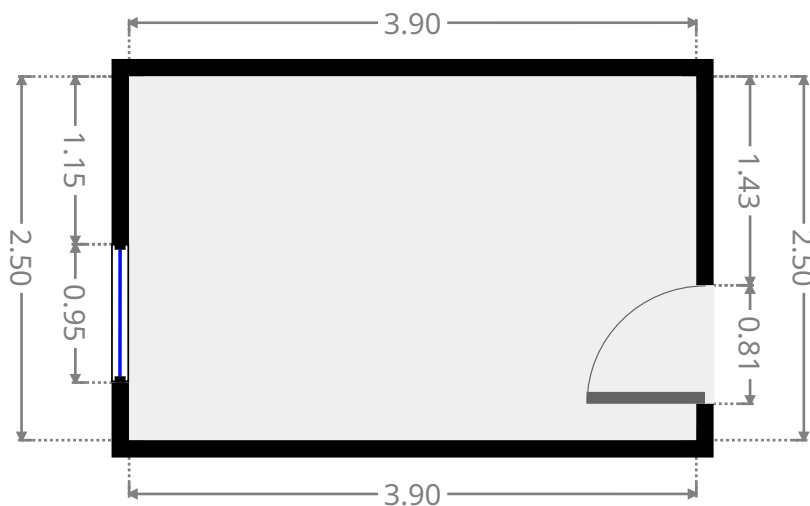
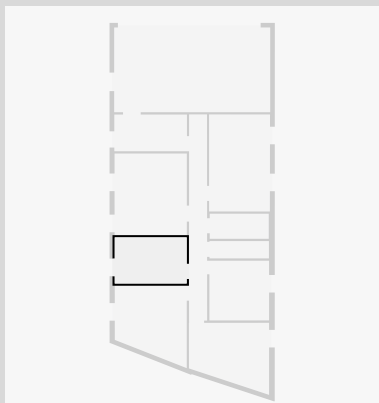

Chambre 2

Largeur 3.90 m
Longeur: 4.48 m
Superficie 14.47 m²
Périmètre: 15.51 m

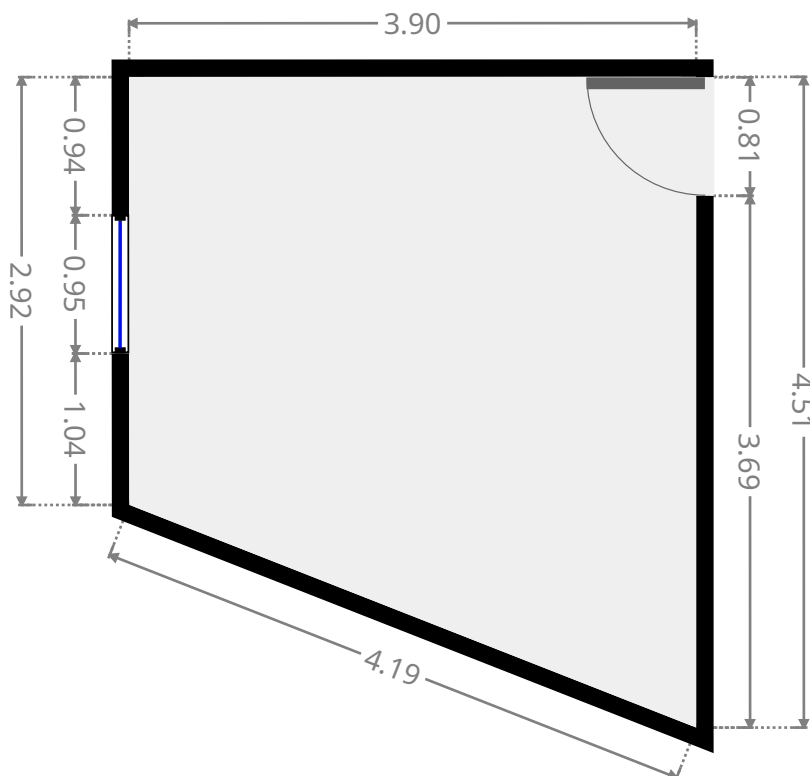
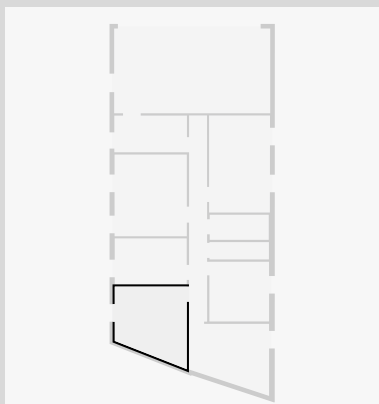

Rêvimmo - 5749512

Salle de bains

Largeur 3.91 m
Longeur: 4.35 m
Superficie 13.85 m²
Périmètre: 15.30 m

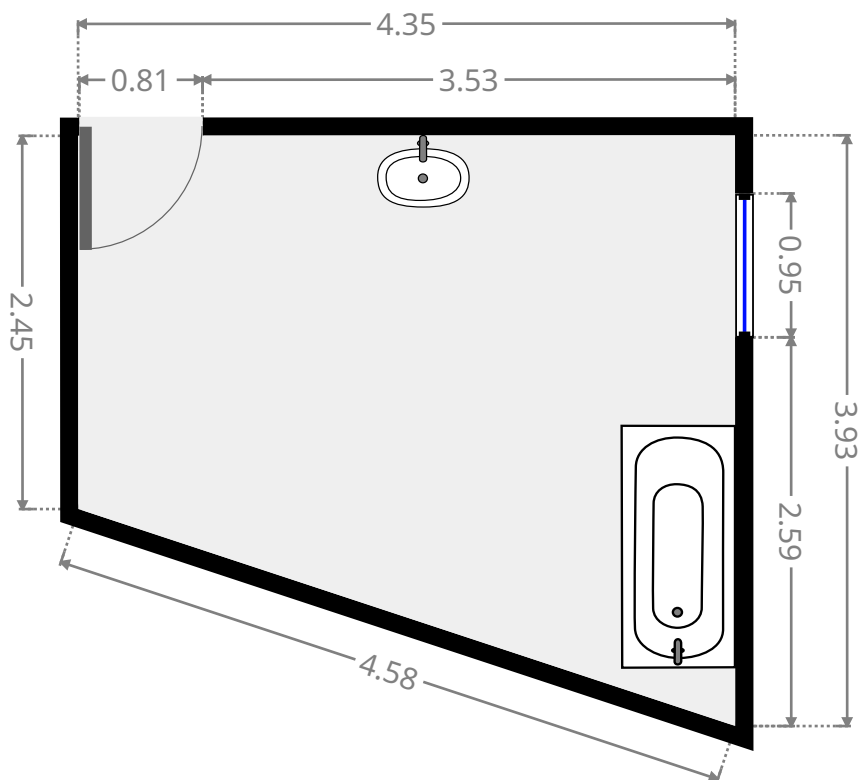
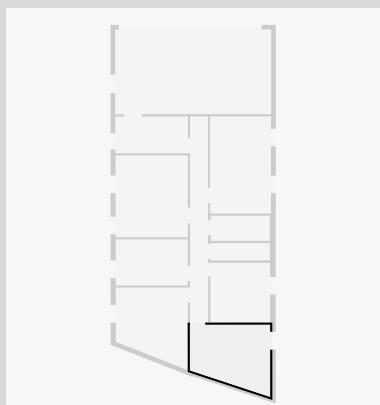

Chambre 4

Largeur 3.23 m
Longeur: 3.24 m
Superficie 10.46 m²
Périmètre: 12.94 m

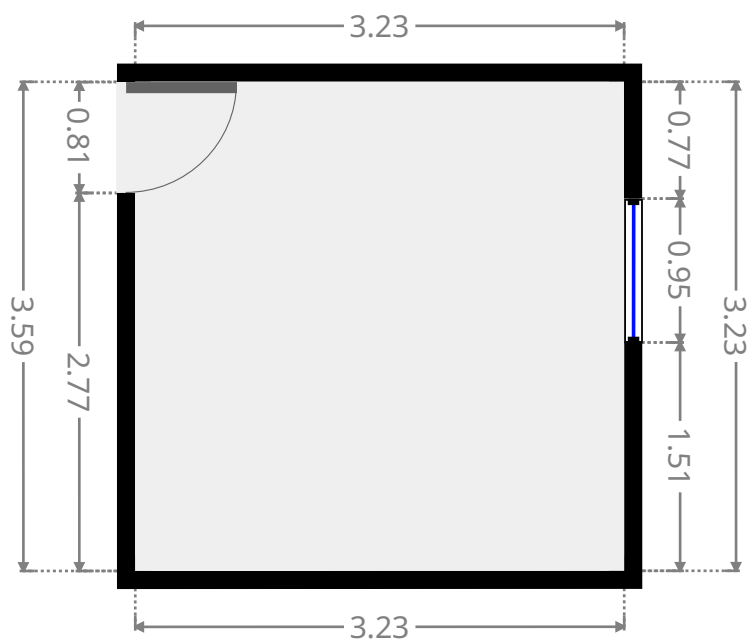
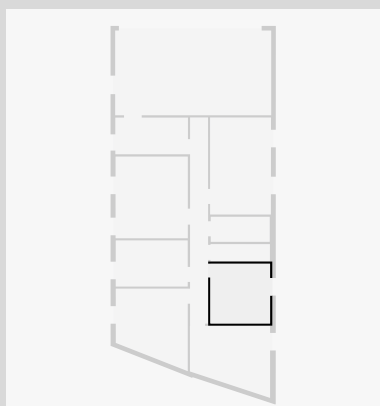

Rêvimmo - 5749512

Escalier 3

Largeur 0.94 m
Longeur: 3.22 m
Superficie 3.02 m²
Périmètre: 8.32 m

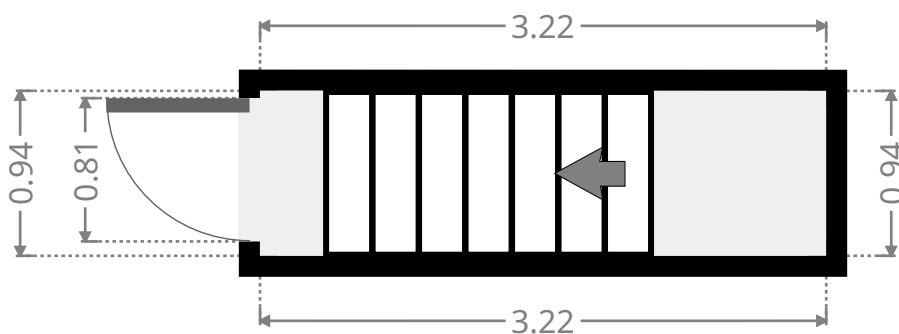
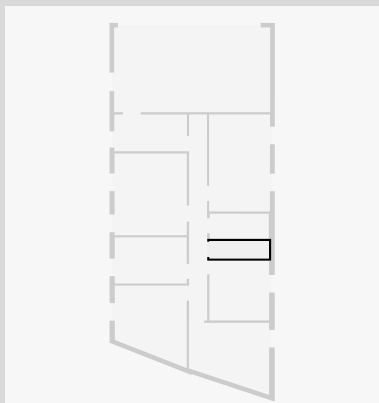

lavabo 5

Largeur 1.36 m
Longeur: 3.20 m
Superficie 4.35 m²
Périmètre: 9.12 m

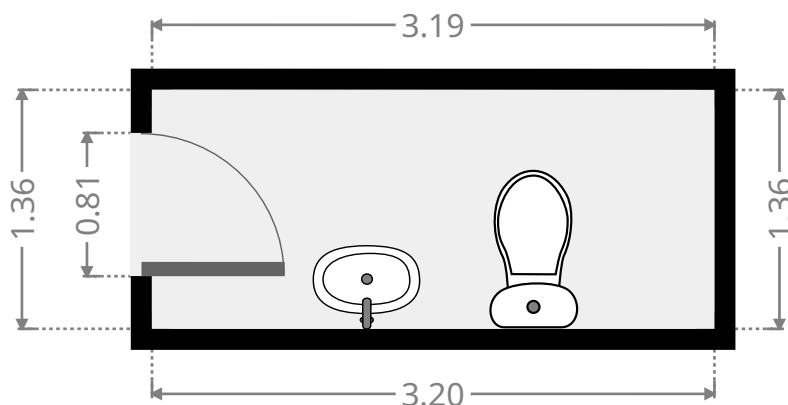
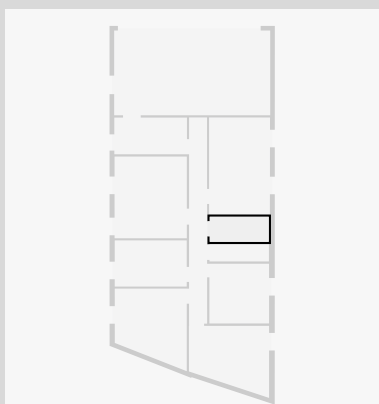

Rêvimmo - 5749512

Chambre 3

Largeur 3.30 m
Longeur: 5.26 m
Superficie 17.35 m²
Périmètre: 17.12 m

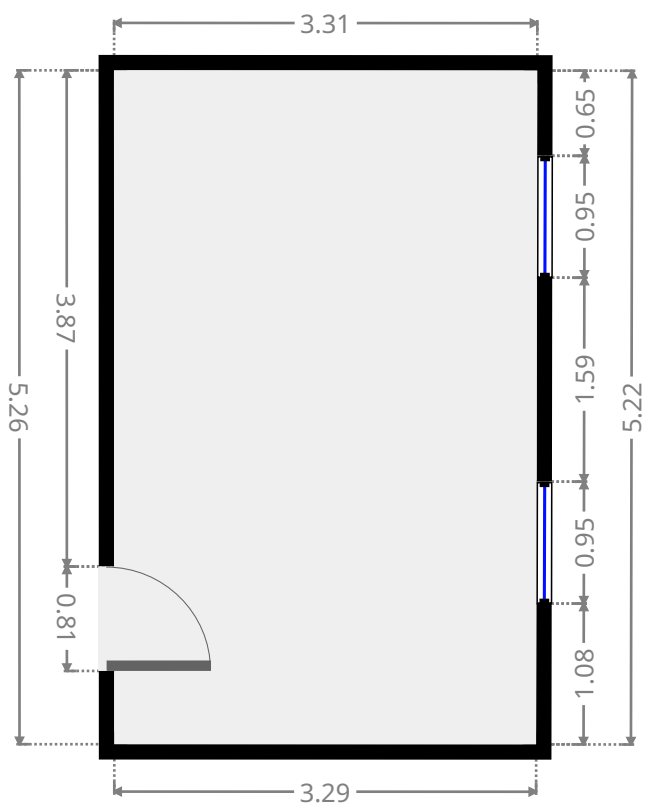
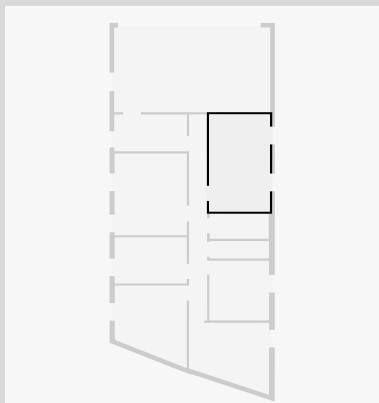

Sous-sol

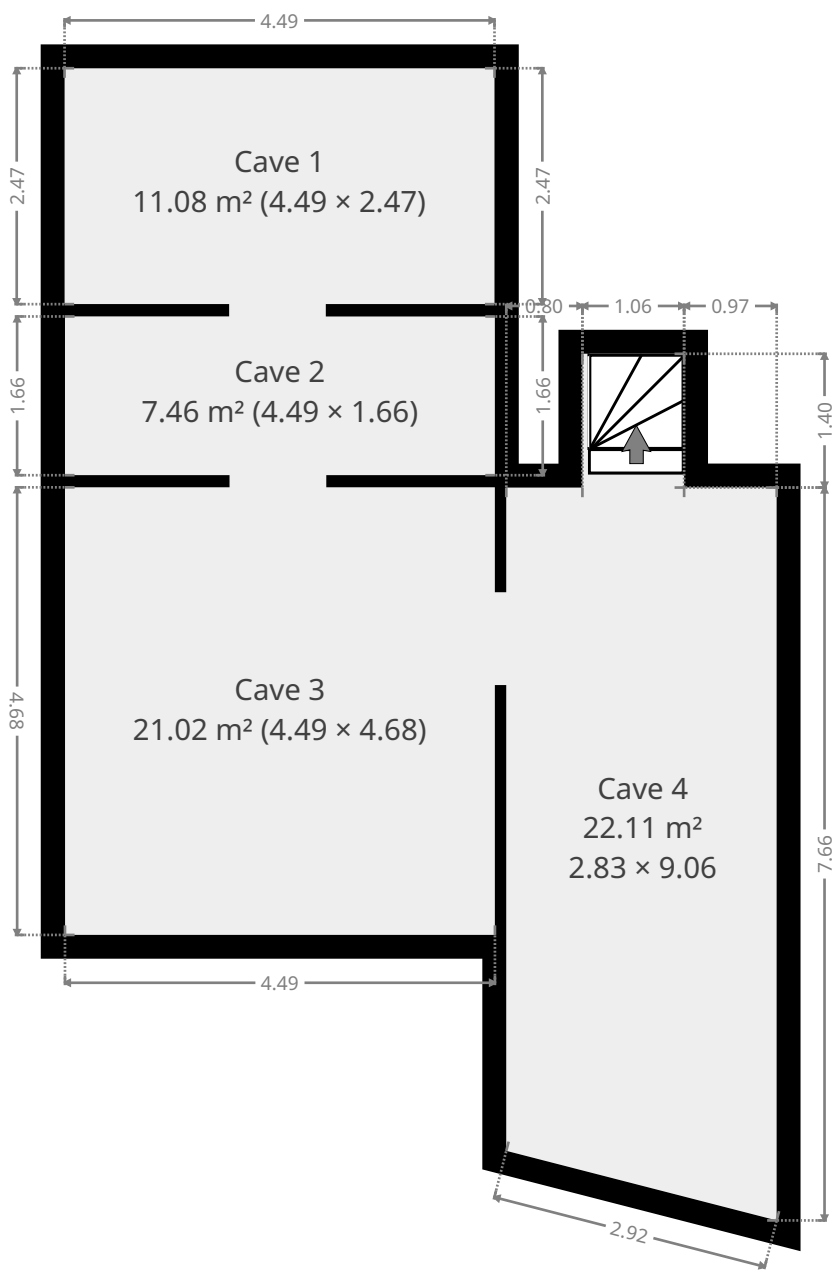

Rêvimmo - 5749512

Cave 1

Largeur 2.47 m
Longeur: 4.49 m
Superficie 11.08 m²
Périmètre: 13.92 m

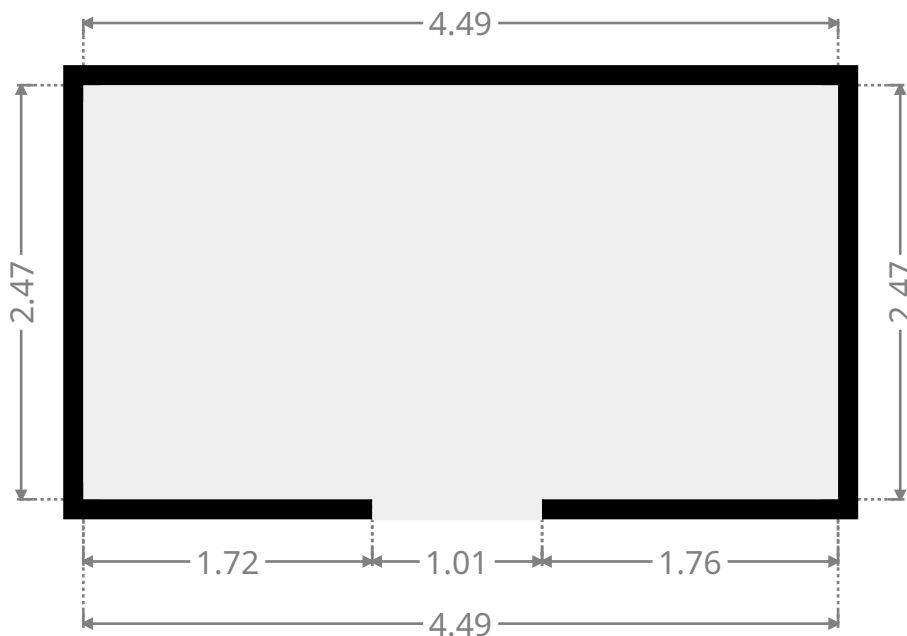
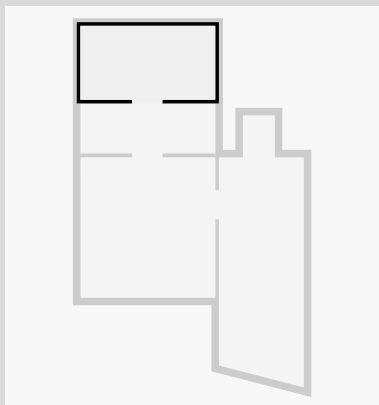

Cave 2

Largeur 1.66 m
Longeur: 4.49 m
Superficie 7.46 m²
Périmètre: 12.31 m

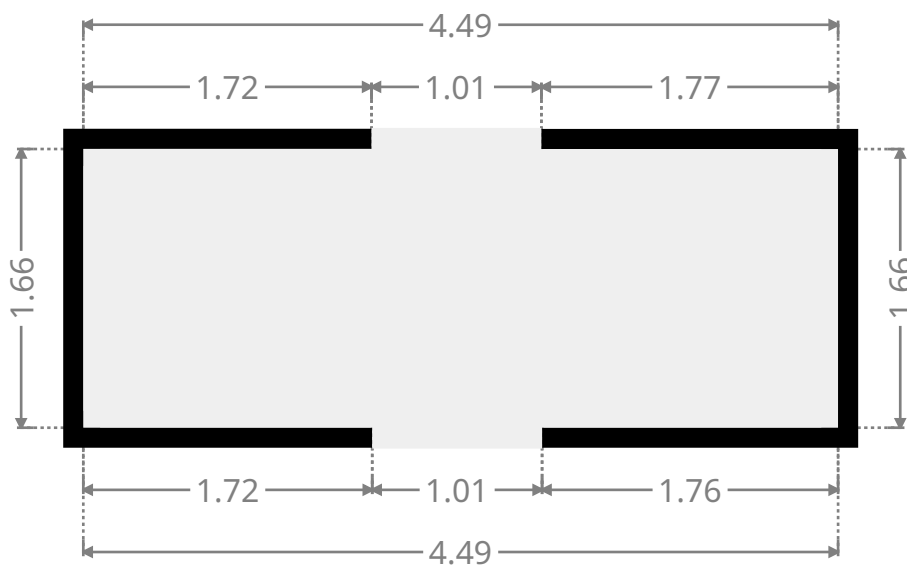
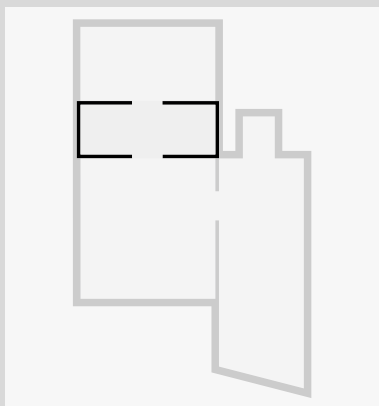

Rêvimmo - 5749512

Cave 3

Largeur 4.49 m
Longeur: 4.68 m
Superficie 21.02 m²
Périmètre: 18.34 m

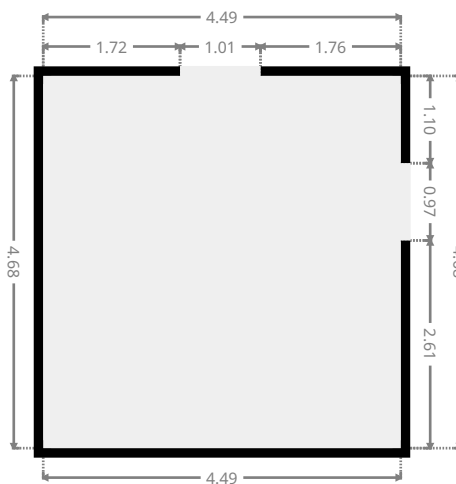
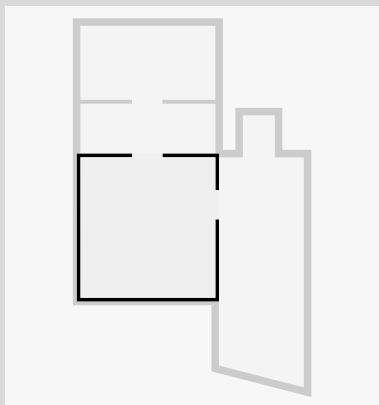

Cave 4

Largeur 2.83 m
Longeur: 9.06 m
Superficie 22.11 m²
Périmètre: 23.13 m

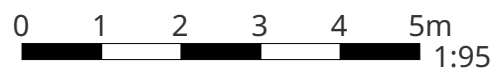
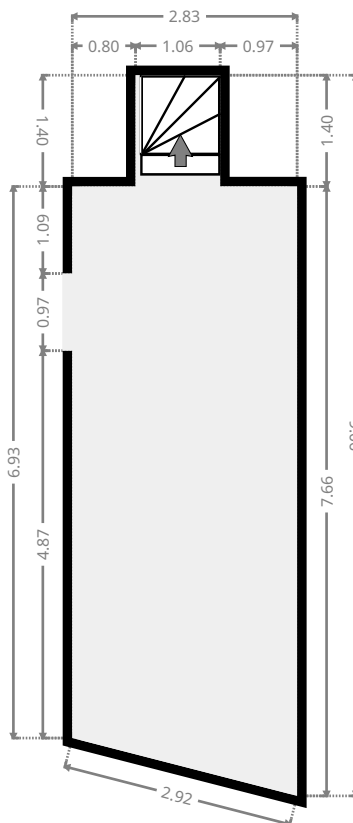
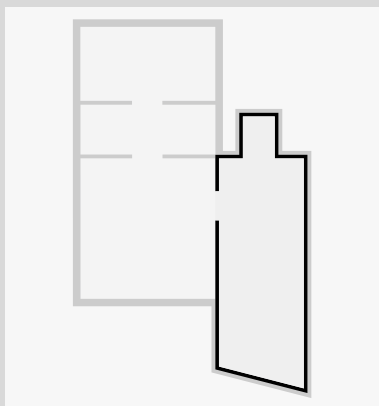

CE PLAN EST FOURNI EN L'ETAT SANS GARANTIE D'AUCUNE SORTE. SENSOPIA N'ACCORDE AUCUNE GARANTIE, Y COMPRIS, SANS S'Y LIMITER, DES GARANTIES QUANT À LA QUALITE ET À LA PRÉCISION DES DIMENSIONS.